

# LIGHTING COLLECTION 2019



CANGINI & TUCCI

ZOE		8
FIJI		22
FLUTE		34
LADY LOUIS		44
SCARLETT		54



# QUALITÀ MADE IN ITALY

QUALITY MADE IN ITALY / QUALITÄT IN ITALIEN GEMACHT

TUTTI I NOSTRI PRODOTTI SONO ACCOMPAGNATI DA UN CERTIFICATO DI GARANZIA CHE NE ATTESTA L'ORIGINALITÀ, LA MANIFATTURA ITALIANA E LA QUALITÀ. I NOSTRI PRODOTTI SONO FRUTTO DELLA PIÙ PURA PRODUZIONE ARTIGIANALE E, DI CONSEGUENZA, ALCUNE IMPERFEZIONI DEL CRISTALLO, DEL COLORE, DEL CAMBIO DI TONALITÀ, NON VENGONO CONSIDERATI DIFETTI MA PREGI, CHE NE GARANTISCONO L'AUTENTICITÀ RENDENDO IL PEZZO UNICO.

ALL OUR PRODUCTS ARE PROVIDED OF A WARRANTY CERTIFICATE THAT AUTHENTICATES THE ORIGINALITY, THE ITALIAN MANUFACTURING AND QUALITY OF THE PRODUCT. WE GUARANTEE THAT OUR PRODUCTS ARE THE RESULT OF THE PUREST HANDMADE PRODUCTION, AND FOR THIS REASON ANY IMPERFECTIONS IN THE CRYSTAL OR COLOUR (OR CHANGES OF TONALITY) ARE NOT DEFECTIVE. EACH HAS PARTICULAR FEATURES THAT GUARANTEE THEIR AUTHENTICITY AND OFFER OUR ESTEEMED CUSTOMERS A OPPORTUNITY TO OWN A UNIQUE PRODUCT TO TREASURE.

ALLE UNSERE PRODUKTE WERDEN VON EINER GARANTIE BEGLEITET, DIE DEREN ORIGINALITÄT, DIE ITALIENISCHE HANDARBEIT UND DIE QUALITÄT BESCHWEINIGEN. UNSERE PRODUKTE SIND DAS ERGEBNIS REINSTER HANDWERKLICHER PRODUKTION UND FOLGLICH SIND EINIGE UNVOLLKOMMENHEITEN DES KRISTALLS, DER FARBE, DER NUANCENÄNDERUNG NICHT ALS FEHLER, SONDERN ALS WERT ZU ERACHTEN, DER DIE AUTHENTIZITÄT DES PRODUKTS GEWÄHRLEISTET UND ES EINZIGARTIG MACHT.



# LINEE DI LUCE

LINES OF LIGHT / LICHTLINIEN



“SEGGI E LINEE PRENDONO FORMA  
TRA FUOCO E MATERIA.  
LA LUCE SI DESCRIVE NELL'IRREGOLARITÀ  
DEL VETRO CREANDO TENUI OMBRE ED ESALTANDO  
TUTTA LA SAPIENZA DI GESTI ANTICHI,  
DOVE L'UNICITÀ DELLA FORMA SI SPOSA AL DESIGN.  
QUESTO È IL NOSTRO MODO DI INTERPRETARE E  
RENDERE VIVA LA LUCE”.

“SIGNS AND LINES TAKE SHAPE  
FROM FIRE AND RAW MATERIALS.  
THE LIGHT IS DESCRIBED IN THE IRREGULARITY  
OF THE GLASS CREATING SOFT SHADOWS  
AND ENHANCING ALL THE WISDOM OF ANCIENT  
GESTURES, WHERE THE UNIQUENESS  
OF THE FORM IS COMBINED WITH DESIGN.  
THIS IS OUR INTERPRETATION OF BRINGING  
LIGHT TO LIFE”.

“ZEICHEN UND LINIEN NEHMEN ZWISCHEN FEUER  
UND MATERIE FORM AN. DAS LICHT BRICHT SICH  
IN DER UNREGELMÄSSIGKEIT DES GLASES, ERZEUGT  
ZARTE SCHATTEN UND HEBT DIE WEISHEIT ANTIKER  
GESTEN HERVOR, WOBEI DIE EINZIGARTIGKEIT  
DER FORM MIT DEM DESIGN KOMBINIERT WIRD.  
DIES IST UNSERE ART, LICHT ZU INTERPRETIEREN  
UND ZUM LEBEN ZU ERWECKEN”.





# METALLIZ- ZAZIONE

METALLIZATION / METALLISIERUNG

IL PROCESSO DI METALLIZZAZIONE VIENE ESEGUITO CON METODO ARTIGIANALE. PICCOLE IMPERFEZIONI PIÙ O MENO EVIDENTI SONO INEVITABILI E NE ATTESTANO VALORIZZANDONE L'ESECUZIONE MANUALE DELLA STESSA. IL PROCESSO NON UTILIZZANDO CODICI RAL PUÒ DARE LUOGO A DIFFERENTI TONALITÀ DI COLORE CHE POSSONO CAMBIARE DA UNA FASE DI LAVORAZIONE ALL'ALTRA A DISTANZA DI TEMPO. L'AZIENDA RISERVA E GARANTISCE UN ATTENTO CONTROLLO DI QUALITÀ.

THE METALLIZATION PROCESS IS HANDCRAFTED. SMALL IMPERFECTIONS ARE INEVITABLE AND THEY ATTEST THE MANUAL EXECUTION OF THE PROCESS. THE PROCESS DOES NOT USE RAL CODES, THEREFORE THIS CAN GIVE RISE TO DIFFERENT SHADES OF COLOUR THAT CAN CHANGE FROM A PHASE OF PRODUCTION TO ANOTHER IN A DISTANCE OF TIME. THE COMPANY RESERVES AND GUARANTEES A CAREFUL QUALITY CONTROL.

SEHR GEEHRTE KUNDE WIR GRATULIEREN FÜR DEN KAUF UNSERER LEUCHTEN DIE METALLISIERUNG PROZESS ERFOLGT IN HANDWERKLICHE VERFAHREN KLEINE IMPERFEKTIONEN SIND NICHT VERHINDERBAR UND WERTSCHÄTZEN DAS KUNST-HANDWERK. LEIDER SIND KEINE STANDARD FARBSKALA EINSETZBAR DAHER SIND LEICHTE TON UNTERSCHIEDE IN DEM FARBERGEBNIS BEI UNTERSCHIEDLICHEN LIEFERUNGEN MÖGLICH. DIE FIRMA GARANTIERT EINE AKKURATE QUALITÄT KONTROLLE.



ZOE™

**LAMPADA DA TAVOLO, APPLIQUE,  
SOSPENSIONE, BINARIO E PLAFONIERA**

*TABLE LAMP, WALL LAMP, HANGING LAMP,  
CEILING TRACK AND CEILING LAMP*







XXL1303.1L





PARALUMI CINETTE DISPONIBILI PER LA LINEA ZOE  
 CINETTE LAMP SHADES AVAILABLE FOR ZOE

BIANCO / ARGENTO  
 WHITE / SILVER



BIANCO / ORO  
 WHITE / GOLD



NERO / ARGENTO  
 BLACK / SILVER



NERO / ORO  
 BLACK / GOLD







GIG1307.120.3L



XXL1303.1L

AP1301.1L





1309MX.3L





## ZOE

## STRUTTURA METALLICA DISPONIBILE / AVAILABLE METAL STRUCTURE:

CROMO / CHROME

(A RICHIESTA: ROSONE BIANCO, NERO, BRONZO, FOGLIA ORO-ARGENTO)

(ON DEMAND: BLACK, WHITE, BRONZE, GOLD-SILVER LEAF CANOPY)

**LU1300**

Lampada da tavolo / Table lamp

vetro/glass Ø16 cm - H33 cm

1 G9 x max 33W 230V

CE IP20 1m

**LUGIG1300**

Lampada da tavolo / Table lamp

vetro/glass Ø22 cm - H43 cm

1 E27 x max 60W 220-240V

CE IP20 1m

**LUXXL1300**

Lampada da tavolo / Table lamp

vetro/glass Ø30 cm - H58 cm

1 E27 x max 60W 220-240V

CE IP20 1m

**LU1303**

Lampada da tavolo / Table lamp

vetro/glass Ø16 cm - H43 cm

1 E14 x max 40W 220-240V

1 LED x 4,3W 350 LUMEN 3.000K

CE IP20 1m

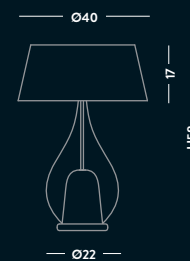
**LUGIG1303**

Lampada da tavolo / Table lamp

vetro/glass Ø22 cm - H58 cm

1 E27 x max 60W 220-240V

1 LED x 4,3W 350 LUMEN 3.000K

CE IP20 1m

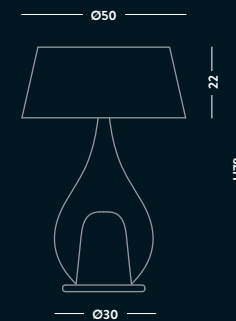
**LUXXL1303**

Lampada da tavolo / Table lamp

vetro/glass Ø30 cm - H78 cm

1 E27 x max 60W 220-240V

1 LED x 4,3W 350 LUMEN 3.000K

CE IP20 1m

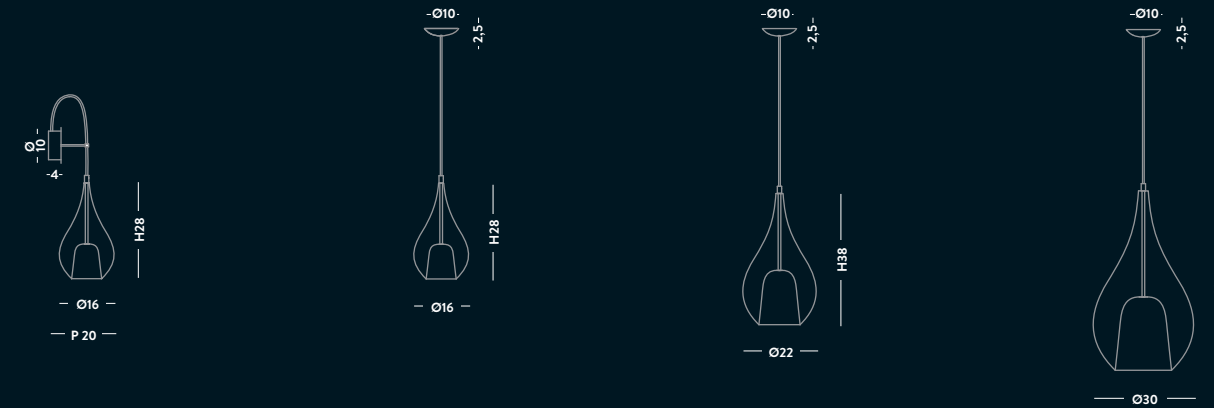
**AP1301.1L**

Applique / Wall lamp

vetro/glass Ø16 cm - cavo/cable 50 cm

1 \*G9 x max 48W 230V

CE IP20 1m

**1303.1L**

Sospensione / Hanging lamp

vetro/glass Ø16 cm - cavo/cable 150 cm

1 \*G9 x max 48W 230V

CE IP20 1m

**GIG1303.1L**

Sospensione / Hanging lamp

vetro/glass Ø22 cm - cavo/cable 150 cm

1 E27 x max 105W 220-240V

CE IP20 1m

**XXL1303.1L**

Sospensione / Hanging lamp

vetro/glass Ø30 cm - cavo/cable 150 cm

1 E27 x max 105W 220-240V

CE IP20 1m

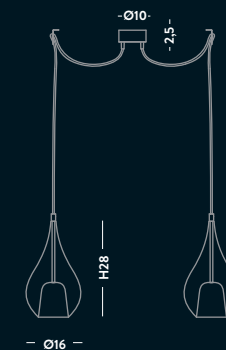
**1303.2L**

Sospensione / Hanging lamp

vetro/glass Ø16 cm - cavo/cable 250 cm

2 \*G9 x max 48W 230V

CE IP20 1m

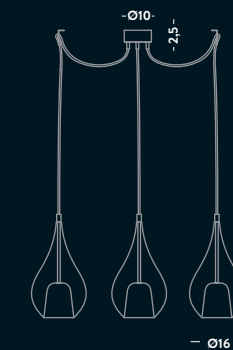
**1303.3L**

Sospensione / Hanging lamp

vetro/glass Ø16 cm - cavo/cable 250 cm

3 \*G9 x max 48W 230V

CE IP20 1m

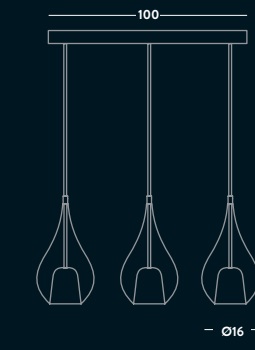
**1307.3L**

Binario a soffitto / Ceiling track

vetro/glass Ø16 cm - cavo/cable 150 cm

3 \*G9 x max 48W 230V

CE IP20 1m

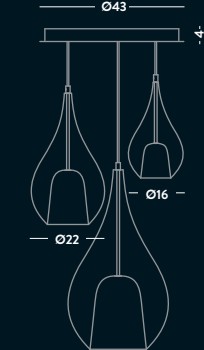
**1309MX.3L**

Plafoniera / Ceiling lamp

vetro/glass Ø16/22/30 cm - cavo/cable 150 cm

1 \*G9 x max 48W 2 E27 x max 105W 220-240V

CE IP20 1m

LU13013- LUGIG1301 - LUXXL1303

I LUMEN INDICATI CORRISPONDONO ALL'INTENSITÀ LUMINOSA ALL'ORIGINE DELLA SCHEDA LED  
LUMEN INDICATED CORRESPONDS TO THE LUMINOUS INTENSITY AT THE ORIGIN OF THE LED BOARD

A RICHIESTA / ON DEMAND

\* SOSPENSIONE / APPLIQUE G9 PUÒ ESSERE REALIZZATO CON ATTACCO E14  
\* HANGING / WALL LAMP G9 CAN BE MADE WITH E14

1307.3L

BINARIO A SOFFITTO / CEILING TRACK:  
ACCIAIO INOX RILUCIDATO  
STAINLESS POLISHED STEEL

1309MX.3L

PLAFONIERA / CEILING LAMP:  
ACCIAIO INOX RILUCIDATO  
STAINLESS POLISHED STEEL

## COLORI VETRO DISPONIBILI / AVAILABLE GLASS COLOURS

01 - Trasparente  
Transparent03 - Rosa  
Pink04 - Iridescente  
Shiny05 - Ambra  
Amber06 - Verde  
Green07 - Azzurro  
Sky-blue08 - Fumè  
Fume16 - Tabacco  
Tobacco17 - Rubino  
Ruby

## COLORI METALLIZZATI VETRO DISPONIBILI / METALLIC GLASS COLOURS AVAILABLE

Rosso  
RedNero  
BlackAcciaio  
SteelOro  
GoldBronzo  
BronzeOra rosa  
Rose goldArcobaleno  
Rainbow





FIJI™

design, Enrico De Lotto

LAMPADA APPLIQUE,  
SOSPENSIONE, E PLAFONIERA

HANGING LAMP, WALL AND CEILING LAMP









GIG1483.1L



GIG1483.1L







1487.120.3L





## FIJI

STRUTTURA METALLICA DISPONIBILE / AVAILABLE METAL STRUCTURE:  
CROMO/CHROME - NERO/BLACK

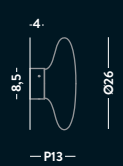
**AP1481.1L**

Applique / Wall lamp

Ø26 cm - P13 cm

1x LED 12,8W 32-40V CC 350mA

CE IP20 Δ 1m

**APGIG1481.1L**

Applique / Wall lamp

Ø34 cm - P16 cm

1x LED 12,8W 32-40V CC 350mA

CE IP20 Δ 1m

**APXXL1481.1L**

Applique / Wall lamp

Ø40 cm - P17 cm

1x LED 12,8W 32-40V CC 350mA

CE IP20 Δ 1m

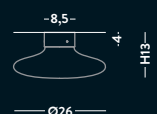
**1482.1L**

Plafoniera / Ceiling lamp

Ø26 cm - H13 cm

1x LED 12,8W 32-40V CC 350mA

CE IP20 Δ 1m

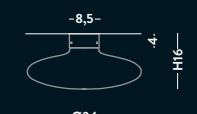
**GIG1482.1L**

Plafoniera / Ceiling lamp

Ø34 cm - H16 cm

1x LED 12,8W 32-40V CC 350mA

CE IP20 Δ 1m

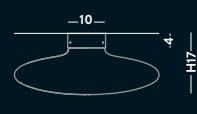
**XXL1482.1L**

Plafoniera / Ceiling lamp

Ø40 cm - H17 cm

1x LED 12,8W 32-40V CC 350mA

CE IP20 Δ 1m

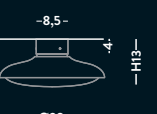
**1486.1L**

Plafoniera / Ceiling lamp

Ø28 cm - H13 cm

1x LED 12,8W 32-40V

CE IP20 Δ 1m

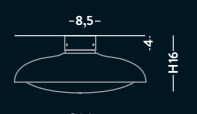
**GIG1486.1L**

Plafoniera / Ceiling lamp

Ø36 cm - H16 cm

1x LED 12,8W 32-40V

CE IP20 Δ 1m

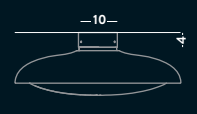
**XXL1486.1L**

Plafoniera / Ceiling lamp

Ø46 cm - H17 cm

1x LED 12,8W 32-40V

CE IP20 Δ 1m

SCHEDA LED SOSTITUIBILE  
LED IS REPLACEABLE

COLORI VETRO DISPONIBILI / AVAILABLE GLASS COLOURS



01 - Trasparente  
Transparent

COLORI METALLIZZATI VETRO DISPONIBILI / METALLIC GLASS COLOURS AVAILABLE



Nero opaco  
Matt black



Oro rosa  
Rose gold



Acciaio  
Steel

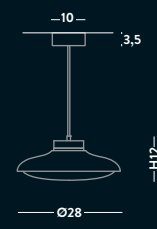

Miele  
Honey

**1483.1L**

Sospensione / Hanging lamp

vetro/glass Ø28 cm - cavo/cable 150 cm

1x LED 12,8W 32-40V CC 350mA

CE IP20 Δ 1m

**GIG1483.1L**

Sospensione / Hanging lamp

vetro/glass Ø36 cm - cavo/cable 150 cm

1x LED 12,8W 32-40V CC 350mA

CE IP20 Δ 1m

**XXL1483.1L**

Sospensione / Hanging lamp

vetro/glass Ø46 cm - cavo/cable 150 cm

1x LED 12,8W 32-40V CC 350mA

CE IP20 Δ 1m

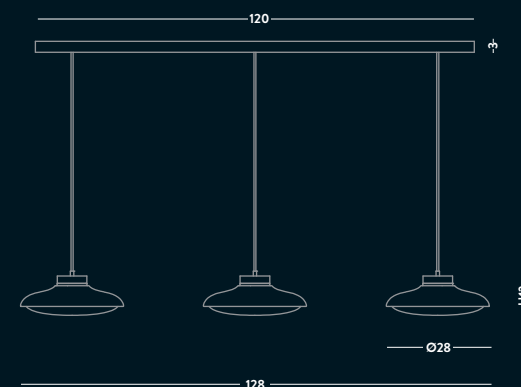
**1487.120.3L**

Binario a soffitto / Ceiling track

L128 - P28 cm - cavo/cable 150 cm

3x LED 12,8W 32-40V CC 350mA

CE IP20 Δ 1m

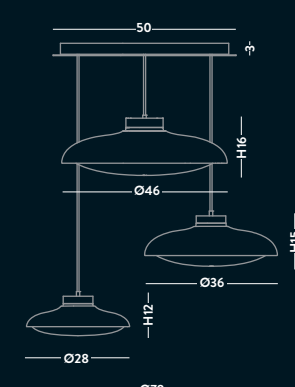
**1489MX.50.3L**

Plafoniera / Ceiling lamp

Ø78 cm - cavo/cable 150 cm

3x LED 12,8W 32-40V CC 350mA

CE IP20 Δ 1m

1487.120.3L  
BINARIO A SOFFITTO / CEILING TRACK:  
ACCIAIO INOX RILUCIDATO  
STAINLESS POLISHED STEEL

- CAVO ELETTRICO IN GOMMA NERO / BLACK RUBBER ELECTRIC CABLE  
- DIFFUSORE IN VETRO SABBIA TO / DIFFUSER IN SANDED GLASS  
- DRIVER INCLUSO / DRIVER INCLUDED

A RICHIESTA COMPONENTI UL +10% UL / ON DEMAND COMPONENTS +10%  
DIMMERABILE SÌ / DIMMABLE YES  
LED 12,8W DIMM - 1615 LM - 126 LM/W - IP20 - CC 350MA - CRI TYP.95 - 32-40V - 180° - 2700°K O/OR 3000°K





# FLUTE

**LAMPADA DA TAVOLO, APPLIQUE,  
SOSPENSIONE, BINARIO E PLAFONIERA**

*TABLE LAMP, WALL LAMP, HANGING LAMP,  
CEILING TRACK AND CEILING LAMP*





XXL1393.1L



1399MX.43.3L





LUGIG1390.1L



GIG1397.120.3L





AP1391.1L

1393MX.2L

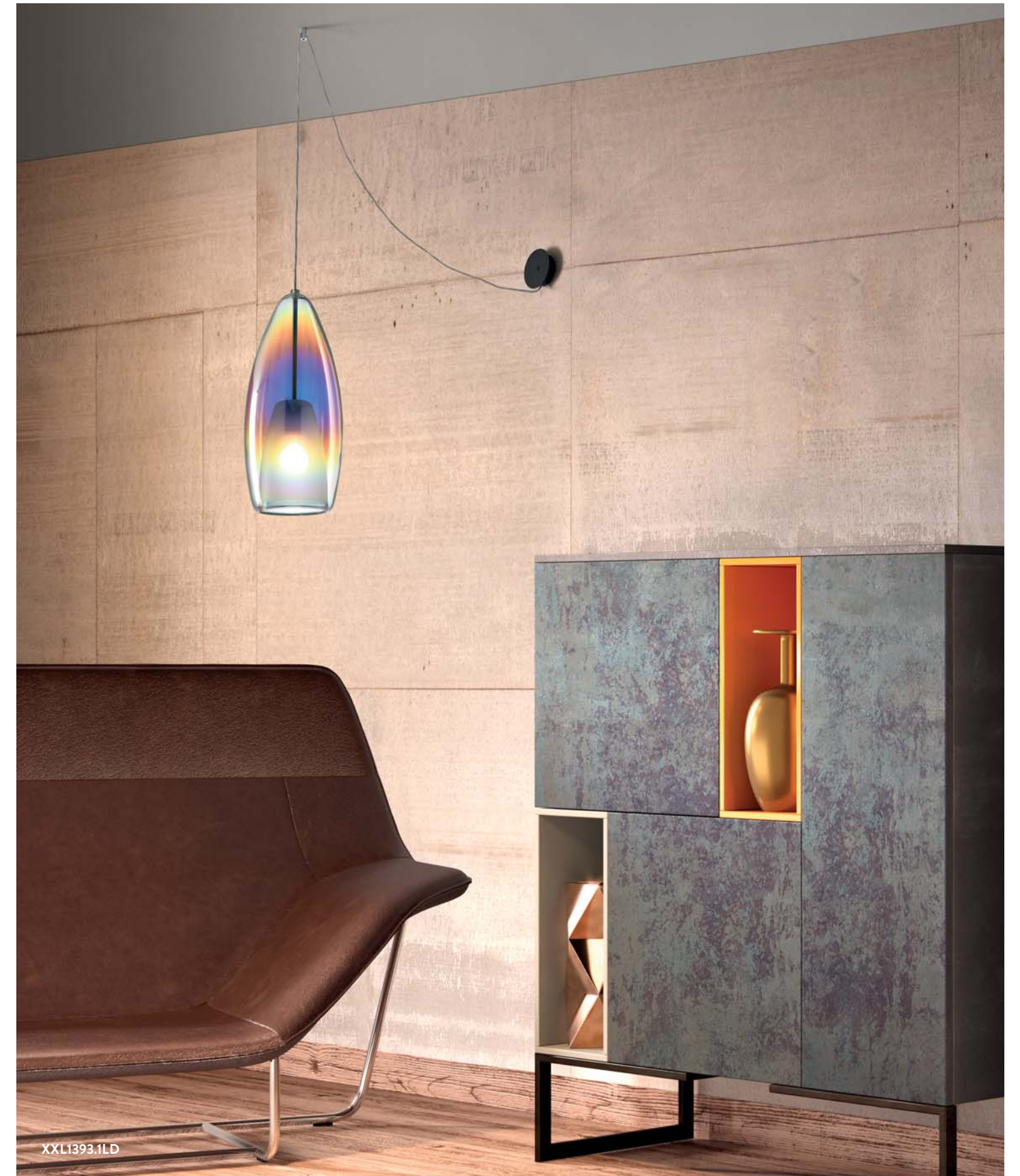

XXL1393.1LD



# FLUTE

STRUTTURA METALLICA DISPONIBILE / AVAILABLE METAL STRUCTURE:  
CROMO/CHROME - NERO/BLACK - BIANCO/WHITE - BRONZO/BRONZE



## 1393.1L

Sospensione / Hanging lamp  
vetro/glass Ø12 cm - cavo/cable 150 cm  
1 E14 x max 60W 220-240V  
CE IP20 1m



## GIG1393.1L

Sospensione / Hanging lamp  
vetro/glass Ø16 cm - cavo/cable 150 cm  
1 E27 x max 105W 220-240V  
CE IP20 1m



## XXL1393.1L

Sospensione / Hanging lamp  
vetro/glass Ø20 cm - cavo/cable 150 cm  
1 E27 x max 105W 220-240V  
CE IP20 1m

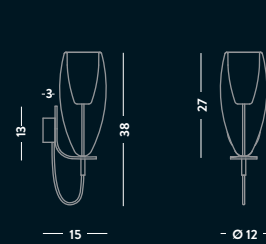

## AP1391.1L

Applique / Wall lamp  
vetro/glass Ø12 cm - cavo/cable 50 cm  
1 E14 x max 60W 220-240V  
CE IP20 1m



## LU1390.1L

Lampada da tavolo / Table lamp  
vetro/glass Ø12 cm - H 31 cm  
1 E14 x max 60W 220-240V  
CE IP20 1m

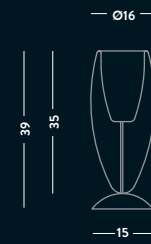

## LUGIG1390.1L

Lampada da tavolo / Table lamp  
vetro/glass Ø16 cm - H 39 cm  
1 E27 x max 105W 220-240V  
CE IP20 1m



## 1393.1LD

Sospensione / Hanging lamp  
vetro/glass Ø12 cm - cavo/cable 250 cm  
1 E14 x max 60W 220-240V  
CE IP20 1m

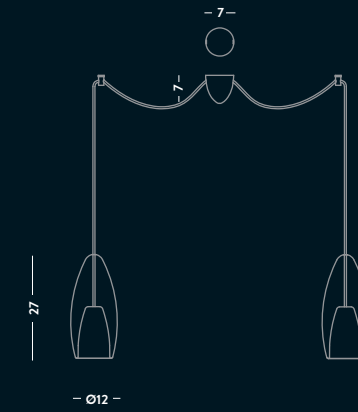

## 1393.2L

Sospensione / Hanging lamp  
vetro/glass Ø12 cm - cavo/cable 250 cm  
2 E14 x max 60W 220-240V  
CE IP20 1m

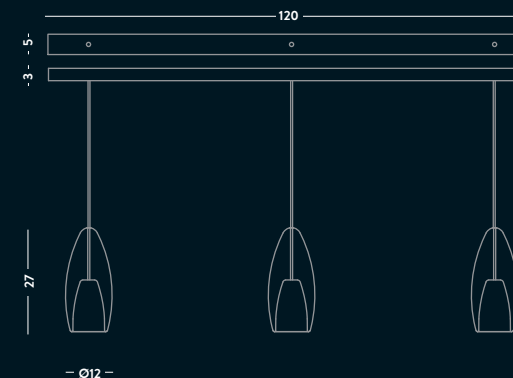

## 1397.120.3L

Binario a soffitto / Ceiling track  
vetro/glass Ø12 cm - cavo/cable 150 cm  
3 E14 x max 60W 220-240V  
CE IP20 1m

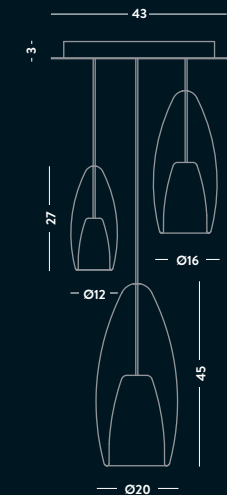

## 1399MX.43.3L

Plafoniera / Ceiling lamp  
vetro/glass Ø12/16/20 cm - cavo/cable 150 cm  
2 E27 x max 105W 1 E14 x max 60W 220-240V  
CE IP20 1m

1397.120.3L  
BINARIO A SOFFITTO / CEILING TRACK.  
ACCIAIO INOX RILUCIDATO / STAINLESS POLISHED STEEL

1399MX.43.3L  
PLAFONIERA / CEILING LAMP.  
ACCIAIO INOX RILUCIDATO / STAINLESS POLISHED STEEL

### COLORI VETRO DISPONIBILI / AVAILABLE GLASS COLOURS



01 - Trasparente / Transparent  
03 - Rosa / Pink  
04 - Iridescente / Shiny  
05 - Ambra / Amber  
06 - Verde / Green  
07 - Azzurro / Sky-blue  
08 - Fumè / Fume  
16 - Tabacco / Tobacco  
17 - Rubino / Ruby

ARTICOLI GIG E XXL NEL COLORE FUMÈ: SUPPLEMENTO DEL 10% SUL PREZZO DEL COLORATO / PRODUCTS GIG AND XXL IN FUME COLOR: 10% SURCHARGE ON THE PRICE OF THE COLOURED

### COLORI METALLIZZATI VETRO DISPONIBILI / METALLIC GLASS COLOURS AVAILABLE



Nero / Black  
Oro rosa / Rose gold  
Acqua marina / Seawater  
Arcobaleno / Rainbow

### STRUTTURA METALLICA DISPONIBILE / AVAILABLE METAL STRUCTURE

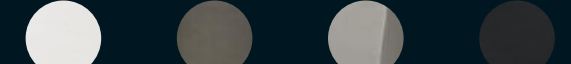

Bianco / White  
Bronzo / Bronze  
Cromo / Chrome  
Nero / Black





# LADY LOUIS<sup>TM</sup>

*design, Alberto Manzoni*

**LAMPADA A SOSPENSIONE,  
PLAFONIERA E BINARIO**

*HANGING LAMP, CEILING LAMP  
AND CEILING TRACK*





XXL1473.1L



GIG1473.1L 1473.1L



1473MX.3L





1473.1L

XXL1473.1L

GIG1473.1L



GIG1473.1L

1473.1L





1477.120.3L



XXL1473.1L



1475MX.3L



# LADY LOUIS

STRUTTURA METALLICA DISPONIBILE / AVAILABLE METAL STRUCTURE:  
CROMO/CHROME - NERO/BLACK



## 1473.1L

Sospensione / Hanging lamp

vetro/glass Ø20 H42 cm - cavo/cable 150 cm

1 G9 x max 42W 230V

CE IP20 1m

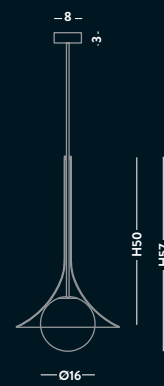

## GIG1473.1L

Sospensione / Hanging lamp

vetro/glass Ø30 H57 cm - cavo/cable 150 cm

1 E27 x max 70W 220-240V

CE IP20 1m

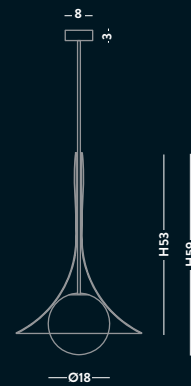

## XXL1473.1L

Sospensione / Hanging lamp

vetro/glass Ø37 H59 cm - cavo/cable 150 cm

1 E27 x max 70W 220-240V

CE IP20 1m

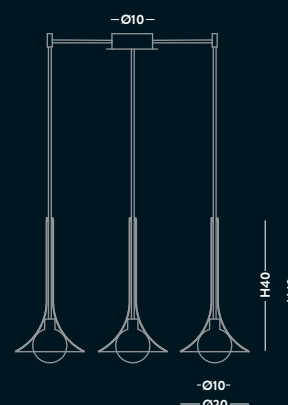

## 1473.3L

Sospensione / Hanging lamp

vetro/glass Ø20 H42 cm - cavo/cable 250 cm

3 G9 x max 42W 230V

CE IP20 1m

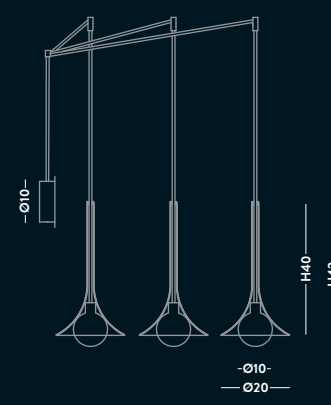

## 1475.3L

Sospensione / Hanging lamp

vetro/glass Ø20 H42 cm - cavo/cable 250 cm

3 G9 x max 42W 230V

CE IP20 1m

COLORI VETRO DISPONIBILI / AVAILABLE GLASS COLOURS



01 - Trasparente  
Transparent

05 - Ambra  
Amber

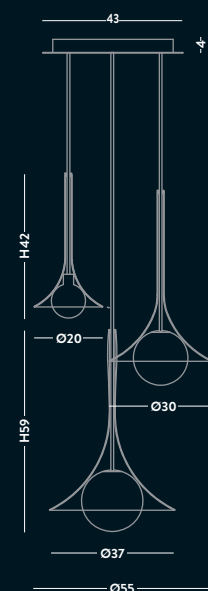

## 1479MX.43.3L

Plafoniera / Ceiling lamp

Ø55 cm - cavo/cable 150 cm

1 G9 x max 42W 2 E27 x max 70W 220-240V

CE IP20 1m

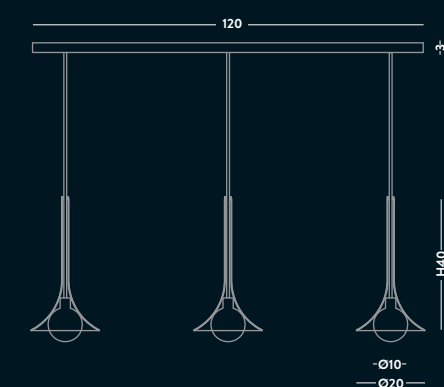

## 1477.120.3L

Binario a soffitto / Ceiling track

L120 - P20 cm - cavo/cable 150 cm

3 G9 x max 42W 230V

CE IP20 1m

1479MX.43.3L  
PLAFONIERA / CEILING LAMP:  
ACCIAIO INOX RILUCIDATO / STAINLESS POLISHED STEEL

1477.120.3L  
BINARIO A SOFFITTO / CEILING TRACK:  
ACCIAIO INOX RILUCIDATO / STAINLESS POLISHED STEEL

- CAVO ELETTRICO GOMMA NERO O TRASPARENTE / BLACK RUBBER OR TRANSPARENT ELECTRIC CABLE  
- DIFFUSORE IN VETRO SABBBIATO / DIFFUSER IN SANDED GLASS

COLORI METALLIZZATI VETRO DISPONIBILI / METALLIC GLASS COLOURS AVAILABLE



Aubergine  
Aubergine

Oro  
Gold

Bronzo  
Bronze





# SCARLETT

design, Alberto Manzoni e Pietro Tucci

LAMPADA APPLIQUE E  
SOSPENSIONE

*HANGING AND WALL LAMP*





1493.8+8/16L





AP1491.1L

# SCARLETT

STRUTTURA IN OTTONE DISPONIBILE / BRASS STRUCTURE AVAILABLE:  
 OTTONE SPAZZOLATO / BRUSHED BRASS (01)  
 BRONZO SPAZZOLATO / BRUSHED BRONZE (02)

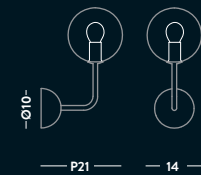

## AP1491.1L

Applique / Wall lamp

L14 cm - P21 - H30 cm

1 E14 x max 42W 220-240V

CE IP20 (1m)

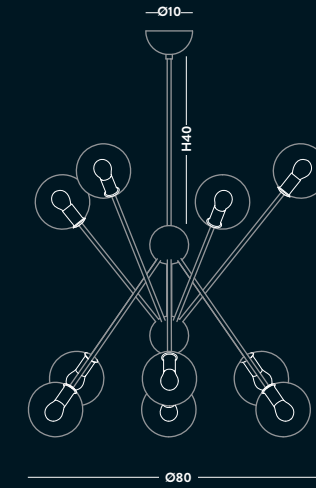

## 1493.6+6/12L

Lampadario / Chandelier

Ø80 cm - H98 cm

12 E14 x max 42W 220-240V

CE IP20 (1m)

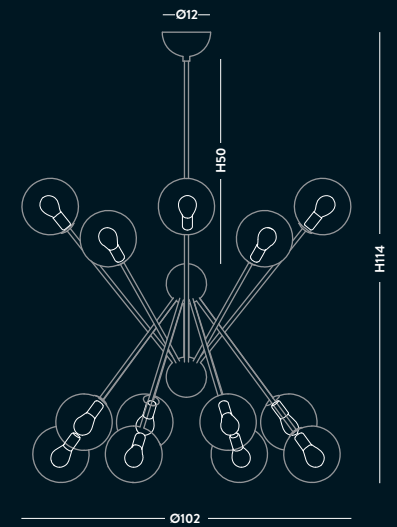

## 1493.8+8/16L

Lampadario / Chandelier

Ø102 cm - H114 cm

16 E14 x max 42W 220-240V

CE IP20 (1m)

### COLORI VETRO DISPONIBILI / AVAILABLE GLASS COLOURS



01 - Trasparente  
Transparent

05 - Ambra  
Amber

16 - Tabacco  
Tabacco

Bianco satinato  
White satin

### STRUTTURA IN OTTONE DISPONIBILE / BRASS STRUCTURE AVAILABLE

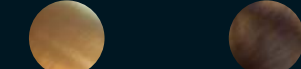

01 - Ottone spazzolato  
Brushed Brass

02 - Bronzo Brunito  
Burnished Bronze











**Amministratore**  
Pietro Tucci

**Product design**  
Cangini e Tucci  
Alberto Manzoni  
Enrico De Lotto

**Fotografia**  
Studio Leon

**Art direction**  
Leonardi and Partners

**Stampa**  
Litografia il Papiro

Si ringrazia Duebi Italia per la fornitura  
dei complementi d'arredo  
pagg. 11, 17, 18, 28, 29, 30, 39,  
40, 41, 51, 52, 53, 58, 59

Foto ambientate (articolo Zoe)  
pagg. 19 Restaurant Portofino  
Light project by [www.fliesen-und-wohnambiente.de](http://www.fliesen-und-wohnambiente.de)

pagg. 60, 61, 63  
Hotel Mezdi \*\*\*S - Visciani Photography

**CANGINI&TUCCI**  
Via Archimede, 235  
47521 Cesena (FC) ITALY  
T +39 0547 303035  
F +39 0547 645146  
[info@canginietucci.com](mailto:info@canginietucci.com)

[www.canginietucci.com](http://www.canginietucci.com)

L'azienda si riserva il diritto  
di apportare modifiche, atte  
al miglioramento del prodotto,  
in qualsiasi momento  
e senza preavviso.

*The company reserves the right  
to make design changes  
to improve the products  
at any time and without notice.*



CANGINI & TUCCI