

BRANDVAN
® **EGMOND**

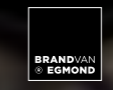

2023



SCULPTURED BY WILLIAM BRAND

William Brand (1963) - an award-winning architect and sculptor - is widely recognized for his imaginative and daring sculptural lighting.

In 1989, he founded his own atelier Brand van Egmond to create without restraint. His lighting sculptures, often perceived as art pieces, grace the finest residences, exclusive boutiques, stunning hotels and leading art exhibitions.

We welcome everybody who wants to see our designs, or would like personal advice from William Brand and his team, to our office and atelier in Naarden, The Netherlands.

BRAND VAN EGMOND

Sculptured by William Brand

"Every design of new collections follows the same sequence. After the first sketches, I quickly move towards the atelier and start working with new materials and shapes by myself. Of every collection I can still feel every curve and twist literally in my hands."



What begins as a simple sketch with William's pen, results in a sculptural lighting object with character, crafted exclusively by hand and with love by skilled artisans, under the direct supervision of William. All creations differ from each other and have little marks of handcrafting, like the colorful patina, grinding structure, little glass characteristics, which give each piece its individual charm.

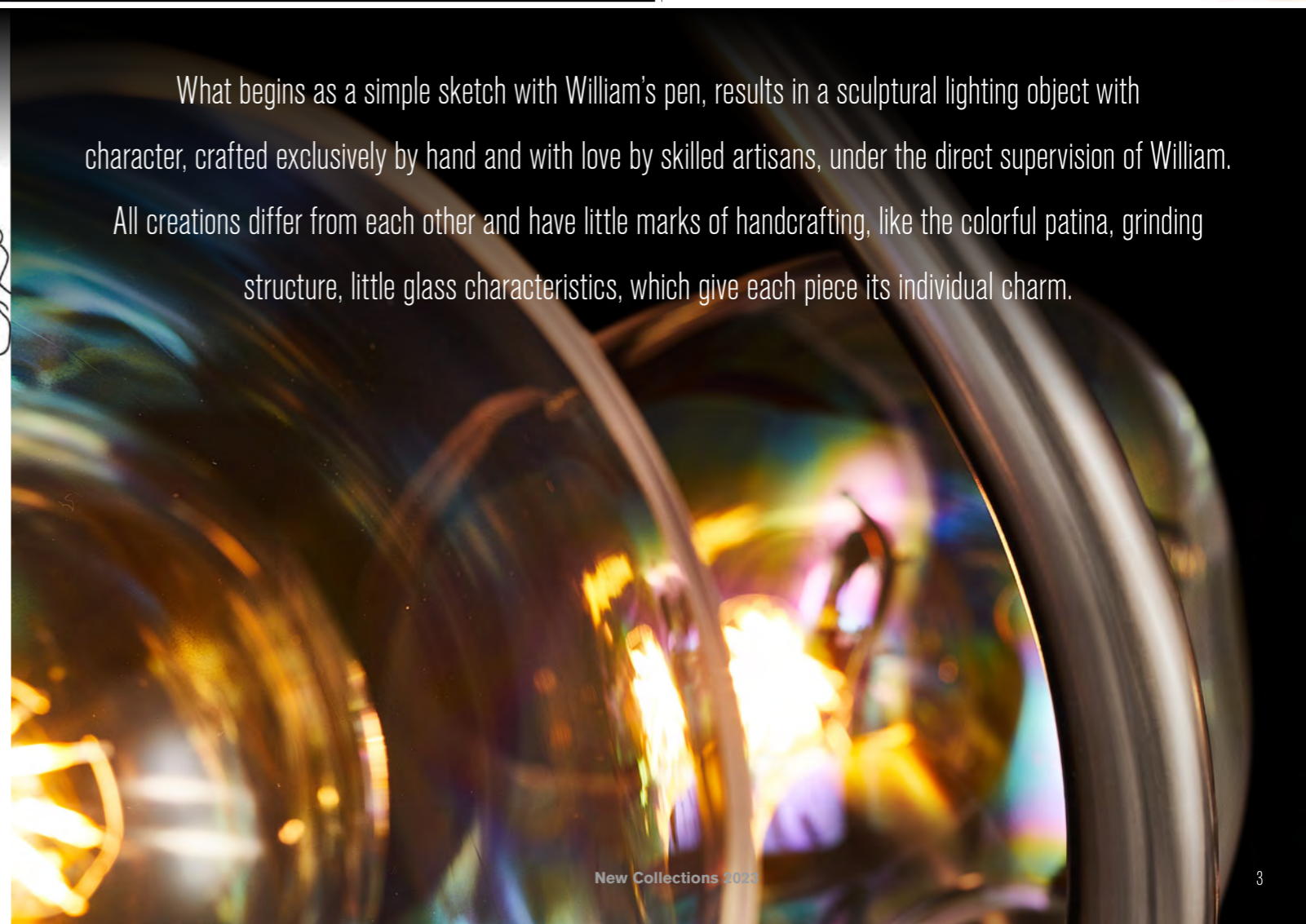







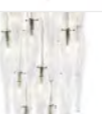









Table of Content



BRAND VAN EGMOND ATELIER

| | COLLECTIONS | COLLECTION IMAGES | TECHNICAL DATA |
|---|------------------------------------|-------------------|----------------|
|  | BELLA | 6 | 104 |
|  | BALLET | 12 | 105 |
|  | BUBBLES | 20 | 106 |
|  | BUBBLES FLOW | 36 | 108 |
|  | BUBBLES SWIRL | 40 | 110 |
|  | SOLIS | 48 | 111 |
|  | PRIMAVERA | 80 | 118 |
|  | PRIMAVERA ICICLES | 88 | 119 |
|  | DESERT WIND | 92 | 120 |
|  | TAKARA | 96 | 121 |
|  | FOUNDER AND DESIGNER WILLIAM BRAND | 102 | |
|  | OPTIONAL FINISHES | 106 | |
|  | TECHNICAL INFO | 104 | |
|  | GENERAL TERMS AND CONDITIONS | 122 | |



Bella

Sculptured by William Brand

Temptation, why resist? As the night proceeds, the last barriers fall. Her necklace, now frozen mid-air yet radiating heat, is captured in Bella.

This floating jewel is a celebration of life, a chic and thoroughly sensual collection of globes and light composed just for your pure delight.

BELC75GSF
Chandelier
Ø75xH.90 cm, 4x E27, 13 kg, gold satin finish



BELC75GSF
Chandelier
Ø75xH.90 cm, 4x E27, 13 kg, gold satin finish



BELC75N
Chandelier
Ø75xH.90 cm, 4x E27, 13 kg, nickel finish



BELC75N
Chandelier
Ø75xH.90 cm, 4x E27, 13 kg, nickel finish



Composition of 3 x BELC75BDP
Chandelier
Ø75xH.90 cm, 4x E27, 13 kg, bronze dark patina finish



BELC75BDP
Chandelier
Ø75xH.90 cm, 4x E27, 13 kg, bronze dark patina finish



Ballet

Sculptured by William Brand

Dancing through the air, the new Ballet exhibits the grandeur and agility of a ballerina.



BALV90BDP
Hanging Lamp Vertical
Ø70xH.90 cm, 2x E27, 7 kg, bronze dark patina finish



BALHL140BDF
Hanging Lamp Horizontal
L.140xW.45xH.50 cm, 2x E27, 11 kg, bronze dark patina finish

Composition of 6xBALV90BDP
Hanging Lamp Vertical
Ø70xH.90 cm, 2x E27, 7 kg, bronze dark patina finish



BALHL140BDP
Hanging Lamp Horizontal
L.140xW.45xH.50 cm, 2x E27, 11 kg, bronze dark patina finish



BALHL140BDP
Hanging Lamp Horizontal
L.140xW.45xH.50 cm, 2x E27, 11 kg, bronze dark patina finish



Composition of 6x BALV90BDP
Hanging Lamp Vertical
Ø70xH.90 cm, 2x E27, 7 kg, bronze dark patina finish

BAL25BDP / BAL35BDP / BAL40BDP
Element
Ø25cm / Ø35cm / Ø40cm, 1x E27, 2 kg, bronze dark patina finish

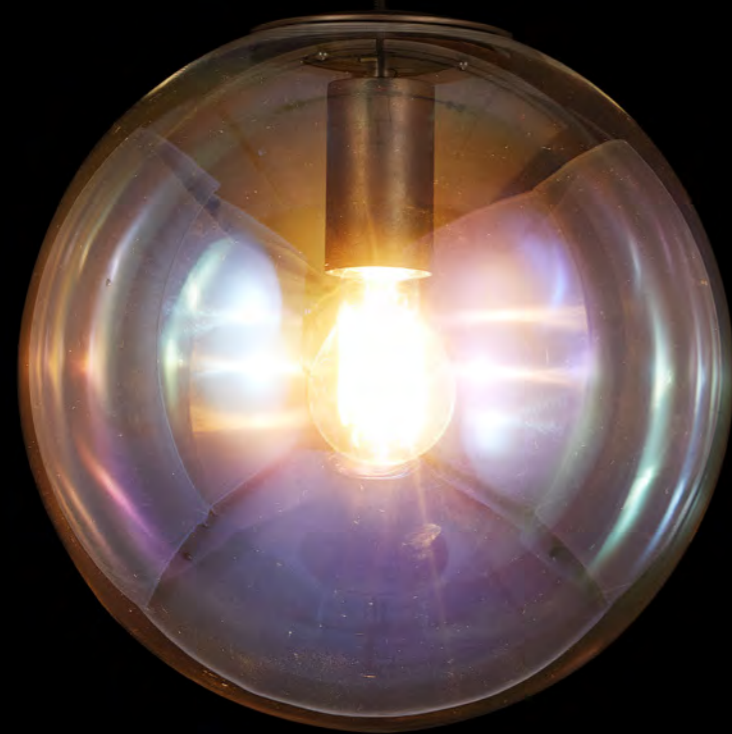

BAL30BDP
Element
Ø30 cm, 1x E27, 2 kg, bronze dark patina finish
Available in Ø25cm / Ø30cm / Ø35cm / Ø40cm



BALHL140BDP
Hanging Lamp Horizontal
L.140xW.45xH.50 cm, 2x E27, 11 kg, bronze dark patina finish

3xBAL35BDP
Element
Ø35 cm, 1x E27, 2 kg, bronze dark patina finish



BUBBLES

Sculptured by William Brand

Carefree bliss while blowing bubbles and being mesmerized by the soothing forms and colours. An Eden of lightness and beauty, innocent and unspoiled. The exploration of freedom and experimentation with materials, with almost childlike delight, resulted into the Bubbles collection.



Composition of 3 x BUBH55N

Hanging Lamp
Ø55xH.60 cm, 1x E27, 2,5 kg, nickel finish

Composition of 2 x BUBC75N

Chandelier
Ø75xH.50 cm, 3x E27, 5,5 kg, nickel finish



BUBH55N

Hanging Lamp

Ø55xH.60 cm, 1x E27, 2,5 kg, nickel finish



BUBH55GSF

Hanging Lamp

Ø55xH.60 cm, 1x E27, 2,5 kg, gold satin finish



Composition of 3x BUBC75N
Chandelier
Ø75xH.50 cm, 3x E27, 5,5 kg, nickel finish



Detail of BUBC75N
Chandelier
Ø75xH.50 cm, 3x E27, 5,5 kg, nickel finish



BUBC75N
Chandelier
Ø75xH.50 cm, 3x E27, 5,5 kg, nickel finish



BUBC75BLM
Chandelier
Ø75xH.50 cm, 3x E27, 5,5 kg, black matt finish



BUBC75GSF

Chandelier

Ø75xH.50 cm, 3x E27, 5,5 kg, gold satin finish



BUBC75GSF

Chandelier

Ø75xH.50 cm, 3x E27, 5,5 kg, gold satin finish



Composition of 4x BUBC90GSF
Chandelier
Ø90xH.65 cm, 5x E27, 8 kg, gold satin finish

BUBH55GSF
Chandelier
Ø55xH.60 cm, 1x E27, 2,5 kg, gold satin finish



BUBC90N
Chandelier
Ø90xH.65 cm, 5x E27, 8 kg, nickel finish



BUBHL140N
Hanging Lamp Long
L.140xW.50xH.40 cm, 5x E27, 9 kg, nickel finish

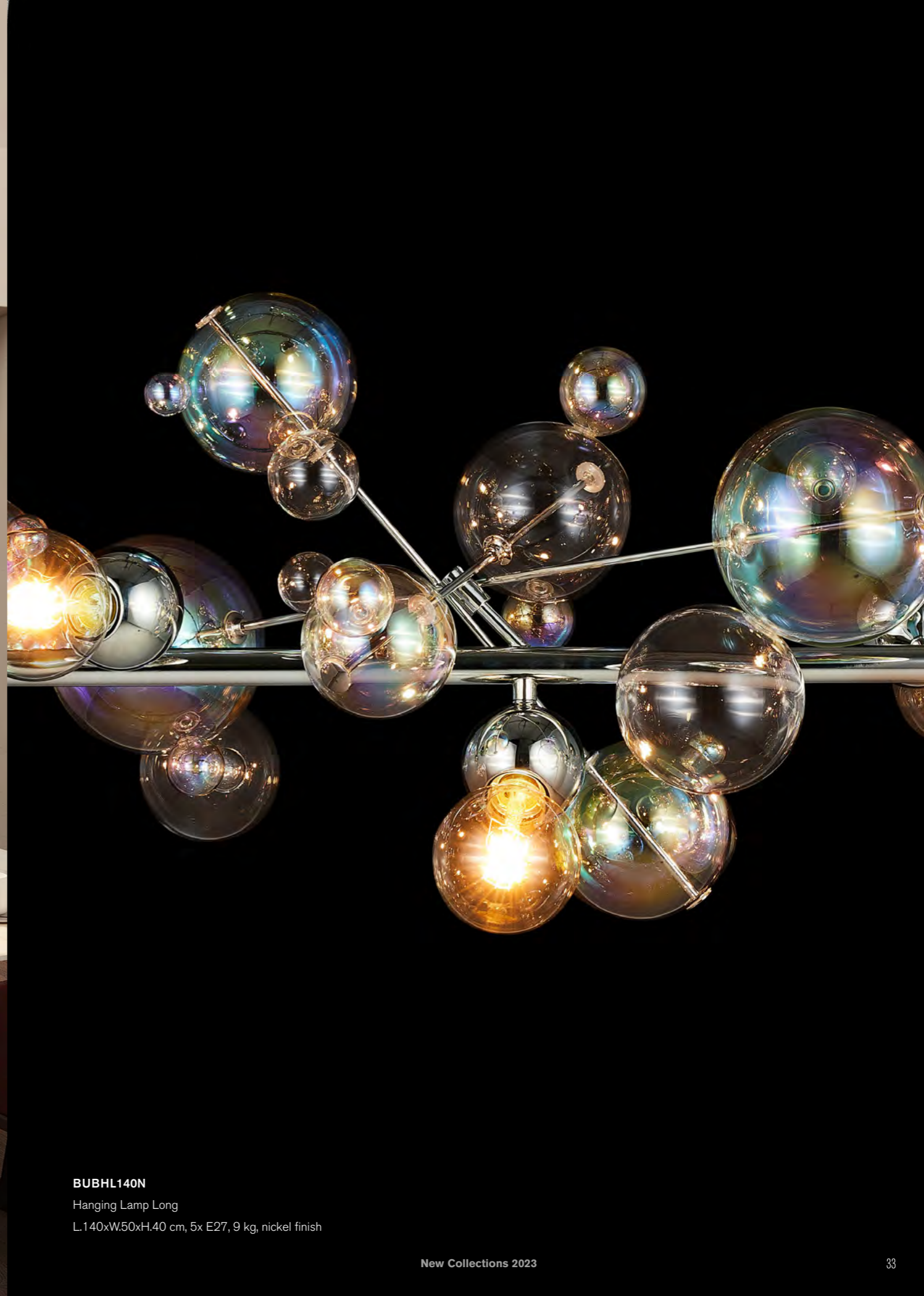

BUBHL140N
Hanging Lamp Long
L.140xW.50xH.40 cm, 5x E27, 9 kg, nickel finish



BUBHL140BDP

Hanging Lamp Long

L.140xW.50xH.40 cm, 5x E27, 9 kg, bronze dark patina finish



BUBBLES Flow

Sculptured by William Brand

With a burst of boundless vitality, the steel and glass of the Bubbles Flow merge and allow for geometrical forms to be created

BUBFCC90BDP
Chandelier Conical
Ø90xH.140 cm, 6x E27, 15 kg, bronze dark patina finish



BUBFCC90BDP
Chandelier Conical
Ø90xH.140 cm, 6x E27, 15 kg, bronze dark patina finish



BUBFC120BDP
Chandelier
Ø120xH.70 cm, 6x E27, 16 kg, bronze dark patina finish



BUBFP65BDP
Ceiling Lamp
Ø65xH.35 cm, 3x E27, 6 kg, bronze dark patina finish



BUBFP90BDP
Ceiling Lamp
Ø90xH.35 cm, 5x E27, 10 kg, bronze dark patina finish



BUBBLES Swirl

Sculptured by William Brand

Independent in spirit and amorphous by heart, the Bubbles Swirl allows for stunning cloud like shapes to be composed.



Composition of 2x BUBSOBJ160BDP

Sculptural Object

W.160xD.120xH.190 cm, 7x E27, 22 kg, bronze dark patina finish

BUBHL140BLM

Hanging Lamp Long

L.140xW.50xH.40 cm, 5x E27, 9 kg, black matt finish

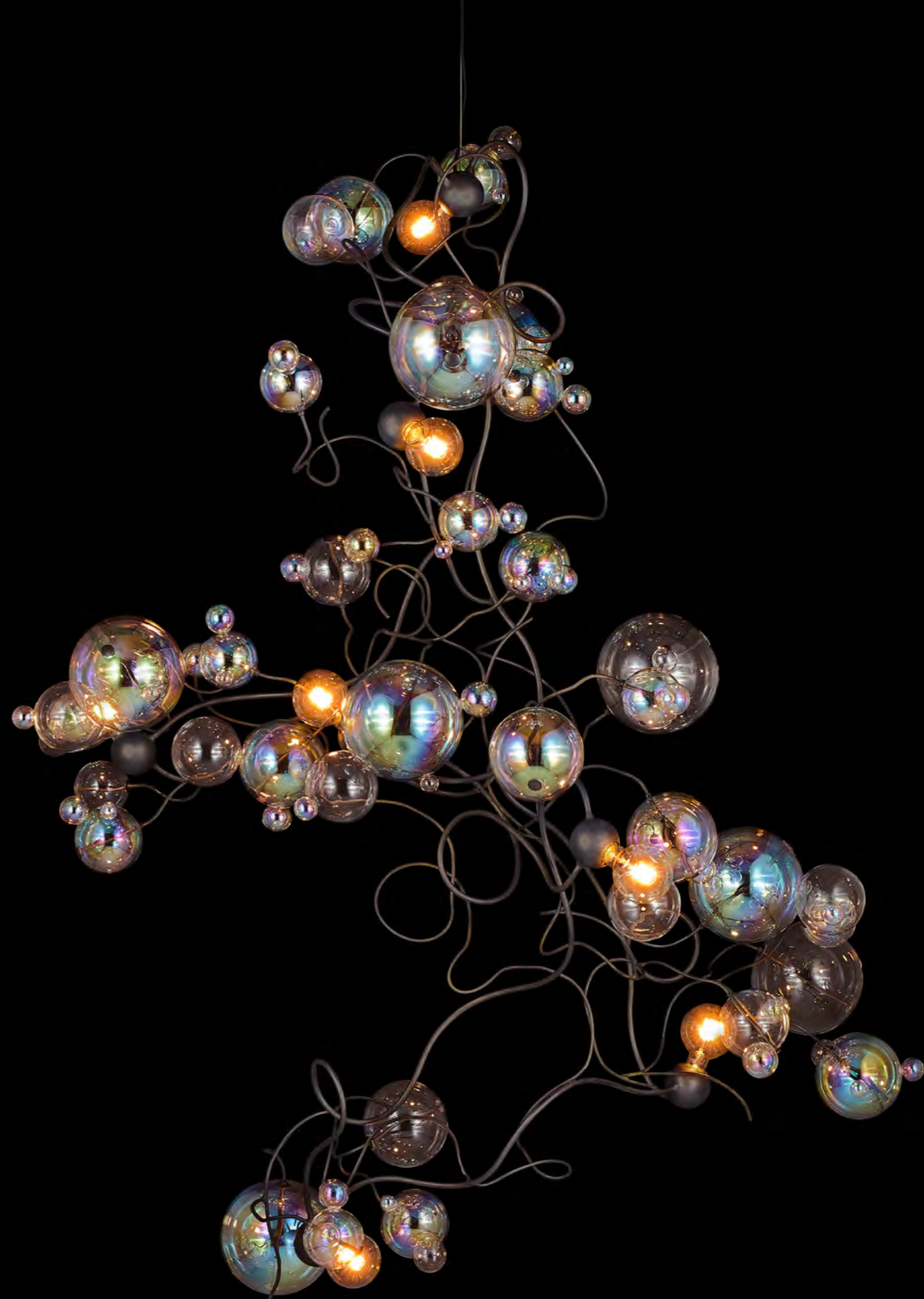

BUBSOBJ160BDP

Sculptural Object

W.160xD.120xH.190 cm, 7x E27, 22 kg, bronze dark patina finish



BUBSOBJ100BDP

Sculptural Object

W.100xD.80xH.100 cm, 3x E27, 9 kg, bronze dark patina finish



BUBSOBJ100BDP

Sculptural Object

W.100xD.80xH.100 cm, 3x E27, 9 kg, bronze dark patina finish



BUBSOBJ100BDP

Sculptural Object

W.100xD.80xH.100 cm, 3x E27, 9 kg, bronze dark patina finish



BUBSH50BDP

Hanging Lamp

W.50xD.40xH.50 cm, 1x E27, 3 kg, bronze dark patina finish



Composition of 5 x BUBSH50BDP

Hanging Lamp

W.50xD.40xH.50 cm, 1x E27, 3 kg, bronze dark patina finish



BUBSH50BDP

Hanging Lamp

W.50xD.40xH.50 cm, 1x E27, 3 kg, bronze dark patina finish



Solis

Sculptured by William Brand

Just as the sun's gravity keeps other planets from spinning into deep space, the Solis pulls your eyes towards the seductive composition of different reflections.

SOLCC70BDP
Chandelier Conical
Ø70xH.80 cm, 12x E14, 21,0 kg, bronze dark patina finish reflectors



SOLCC70BDP-ST
Chandelier Conical
Ø70xH.80 cm, 12x E14, 21,0 kg, bronze dark patina finish finish with stainless steel reflectors



SOLCC70BDP-BR BUR

Chandelier Conical

Ø70xH.80 cm, 12x E14, 21,0 kg, bronze dark patina finish with brass burnished reflectors



SOLOC120BLM-BDP

Chandelier Oval

L.120xW.70xH.50 cm, 12x E14, 20,0 kg, black matt finish with bronze dark patina finish reflectors



SOLOC120BLM-GSF

Chandelier Oval

L.120xW.70xH.50 cm, 12x E14, 20,0 kg, black matt finish with gold satin reflectors



SOLOC120BLM-GSF

Chandelier Oval

L.120xW.70xH.50 cm, 12x E14, 20,0 kg, black matt finish with gold satin reflectors



SOLOC120BLM-BR BUR

Chandelier Oval

L.120xW.70xH.50 cm, 12x E14, 20,0 kg, black matt finish with brass burnished reflectors



SOLOC120BLM-BR BUR

Chandelier Oval

L.120xW.70xH.50 cm, 12x E14, 20,0 kg, black matt finish with brass burnished reflectors



SOLC100BDP
Chandelier Round
Ø100xH.155 cm, 12x E14, 22,0 kg, bronze dark patina finish



SOLC100BDP
Chandelier Round
Ø100xH.155 cm, 12x E14, 22,0 kg, bronze dark patina finish



SOLC100BDP-ST

Chandelier Round

Ø100xH.155 cm, 12x E14, 22,0 kg, bronze dark patina finish with stainless steel reflectors



SOLC100BDP-GSF

Chandelier Round

Ø100xH.55 cm, 10x E14, 22,0 kg, bronze dark patina finish with gold satin reflectors



SOLC100BDP-BRBUR

Chandelier Round

Ø100xH.55 cm, 10x E14, 22,0 kg, bronze dark patina finish with brass burnished reflectors



SOLH55BLM-ST
Hanging Lamp
Ø55xH.40 cm, 5x E14, 7,0 kg, black matt finish with stainless steel reflectors



2x SOLH55BLM-ST
Hanging Lamp
Ø55xH.40 cm, 5x E14, 7,0 kg, black matt finish with stainless steel reflectors

SOLH65BDP-ST
Hanging Lamp
Ø65xH.40 cm, 5x E14, 7,0 kg, bronze dark patina finish with stainless steel reflectors





Customised finish SOLH40N-ST

Hanging Lamp

Ø40xH.30 cm, 5x E14, 5,0 kg, nickel finish with stainless steel reflectors



SOLH55BLM-BDP

Hanging Lamp

Ø55xH.40 cm, 5x E14, 7,0 kg, black matt finish with bronze dark patina reflectors

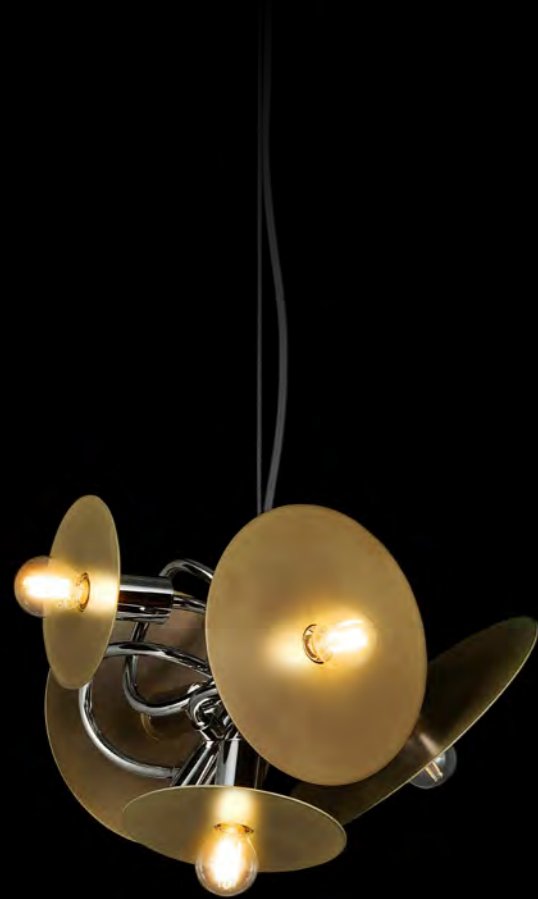

Customized finish SOLH40N-BRBUR

Hanging Lamp
Ø40xH.30 cm, 5x E14, 5,0 kg, nickel finish with
brass burnished reflectors

SOLH55BLM-BRBUR

Hanging Lamp
Ø55xH.40 cm, 5x E14, 7,0 kg, black matt finish with
brass burnished reflectors

SOLH65BDP-BRBUR

Hanging Lamp
Ø65xH.40 cm, 5x E14, 7,0 kg, bronze dark patina finish with brass burnished reflectors



SOLH65BDP-ST

Hanging Lamp

Ø65xH.40 cm, 5x E14, 7,0 kg, bronze dark patina finish with stainless steel reflectors



SOLH65BDP

Hanging Lamp

Ø65xH.40 cm, 5x E14, 7,0 kg, bronze dark patina finish with bronze dark patina reflectors



SOLHL125BLM-BDP
Hanging Lamp Long
L.125xW.45xH.40 cm, 12x E14, 15,5 kg, black matt finish with bronze dark patina reflectors



SOLHL125BLM-BDP
Hanging Lamp Long
L.125xW.45xH.40 cm, 12x E14, 15,5 kg, black matt finish with bronze dark patina reflectors



SOLHL125BLM-BRBUR

Hanging Lamp Long

L.125xW.45xH.40 cm, 12x E14, 15,5 kg, black matt finish with brass burnished reflectors



Customised finish SOLV150GSF

Hanging Lamp Vertical

Ø50xH.150 cm, 14x E14, 17 kg, bronze dark patina finish with gold satin reflectors



Customised finish SOLV150GSF-BLM

Hanging Lamp Vertical

Ø50xH.150 cm, 14x E14, 17 kg, bronze dark patina finish with black matt reflectors



SOLF200BDP
Floor Lamp
Ø50xH.200 cm, 7x E14, 27 kg, bronze dark patina finish



SOLF200BDP-BR BUR
Floor Lamp
Ø50xH.200 cm, 7x E14, 27 kg, bronze dark patina finish with
brass burnished reflectors



SOLF200BDP-ST
Floor Lamp
Ø50xH.200 cm, 7x E14, 27 kg, bronze dark patina finish with
stainless steel reflectors



Customized finish SOLT75N-BDP
Table Lamp
Ø40xH.75 cm, 5x E14, 10 kg, nickel finish with
bronze dark patina finish



Customized finish SOLT75N-ST
Table Lamp
Ø40xH.75 cm, 5x E14, 10 kg, nickel finish with
stainless steel reflectors

CEILING LIGHTS CAN BE USED AS WALL OBJECTS



SOLP35BDP-ST

Ceiling Lamp
Ø35xH.20 cm, 3x E14, 5 kg, bronze dark patina finish with stainless steel reflectors

SOLP35BDP-BR BUR

Ceiling Lamp
Ø35xH.20 cm, 3x E14, 5 kg, bronze dark patina finish with brass burnished reflectors

SOLP35BDP

Ceiling Lamp
Ø35xH.20 cm, 3x E14, 5 kg, bronze dark patina finish with bronze dark patina finish reflectors



SOLP65BDP-ST

Ceiling Lamp
Ø65xH.25 cm, 5x E14, 8 kg, bronze dark patina finish with stainless steel reflectors

SOLW35BDP

Wall Lamp
Ø35xH.20 cm, 3x E14, 5 kg, bronze dark patina finish

SOLW35BDP-BR BUR

Wall Lamp
Ø35xH.20 cm, 3x E14, 5 kg, bronze dark patina finish with brass burnished reflectors



SOLP90BDP-GSF

Ceiling Lamp
Ø90xH.25 cm, 5x E14, 10 kg, bronze dark patina finish with gold satin reflectors



CEILING LAMPS SOLP65 AND SOLP90 CAN BE USED AS WALL OBJECTS

Wall Lamp
Ø90xH.25 cm, 5x E14, 10 kg, bronze dark patina finish with gold satin reflectors



Primavera

Sculptured by William Brand

Merging after the long winter cold, the first rays of spring warm the Earth and all she carries. The old tree, overgrown with years and ice, has survived and will thrive once again.



PR130BRBUR
Element
Ø30xH.80 cm , 3x G9 , 4,5 kg , brass burnished finish

PRIC60BRBUR
Chandelier
Ø60xH.92 cm , 6x G9 , 13,5 kg , brass burnished finish



PRIC90GSF
Chandelier
Ø90xH.107 cm , 12x G9 , 25 kg , gold satin finish



PRIC90WM

Chandelier

Ø90xH.107 cm , 12x G9 , 25 kg , white matt finish



PRIC60BLM

Chandelier

Ø60xH.92 cm , 6x G9 , 13,5 kg , black matt finish



PRIC60BRBUR

Chandelier

Ø60xH.92 cm , 6x G9 , 13,5 kg , brass burnished finish



PRI30GSF

Element

Ø30xH.80 cm , 3x G9 , 4,5 kg , gold satin finish



PRIW50BRBUR

Wall Lamp

W.10xH.52xD.17 cm , 1x G9 , 4 kg , brass burnish finish



PRIW50BDP

Wall Lamp

W.10xH.52xD.17 cm , 1x G9 , 4 kg , bronze dark patina finish



PRIW50BLM

Wall Lamp

W.10xH.52xD.17 cm , 1x G9 , 4 kg , black matt finish



Primavera Icicles

Sculptured by William Brand

Create your own composition of light, glass and splendour.

The hollow Icicles, available in 35 and 50 cm height, can be used to create any formation you wish for.

An installation of magnificence for a grand lobby or a subtle composition over a table?

All possibilities are within reach with the Primavera Icicles.



Composition of PRISI35N and PRISI50N

Element

Ø10xH.35 cm, 1x G9, 1 kg, nickel finish and Ø10xH.50 cm, 1x G9, 1 kg, nickel finish



Composition of PRISI35N and PRISI50N

Element

Ø10xH.35 cm, 1x G9, 1 kg, nickel finish and Ø10xH.50 cm, 1x G9, 1 kg, nickel finish



Composition of PRISI35N and PRISI50N

Element

Ø10xH.35 cm, 1x G9, 1 kg, nickel finish and Ø10xH.50 cm, 1x G9, 1 kg, nickel finish



Composition of PRISI50N

Element

Ø10xH.50 cm, 1x G9, 1 kg, nickel finish



Desert Wind

Sculptured by William Brand

Raw yet elegant, the Desert Wind draws from the same journey to Namibia of founder William Brand that led to other collections from his hand. Yesterday and tomorrow cross and merge into this lighting sculpture, both lost in the haze of the warming light.

DEWCC80BLM
Chandelier Conical
Ø80xH.80 cm , 9x G14 , 22 kg , black matt finish

SOLW35BDP
Wall Lamp
Ø35xH.20 cm , 3x E14 , 5 kg , bronze dark patina finish



DEWOC140BLM
Chandelier Oval
L.140xW.65xH.55 cm , 10x E14 , 27 kg , black matt finish



DEWC125BLM

Chandelier Round

Ø125xH.55 cm , 11x E14 , 25 kg , black matt finish



TAKARA

Sculptured by William Brand

The Takara, Japanese for treasure, is a sculptural and evocative piece of art that is at the same time functional.

Casted in bronze, crafted by hand and created for generations to come.



TAKHL200BDP

Hanging Lamp Long

L.194xW.18xH.14 cm , 2x LED STRIPE L. 150CM , 27 kg , cast bronze dark patina finish



TAKHL150BDP

Hanging Lamp Long

L.142xW.12xH.14 cm , 2x LED STRIPE L. 100CM , 21 kg , cast bronze dark patina finish



TAKHL200BDP

Hanging Lamp Long

L.194xW.18xH.14 cm , 2x LED STRIPE L. 150CM , 27 kg , cast bronze dark patina finish



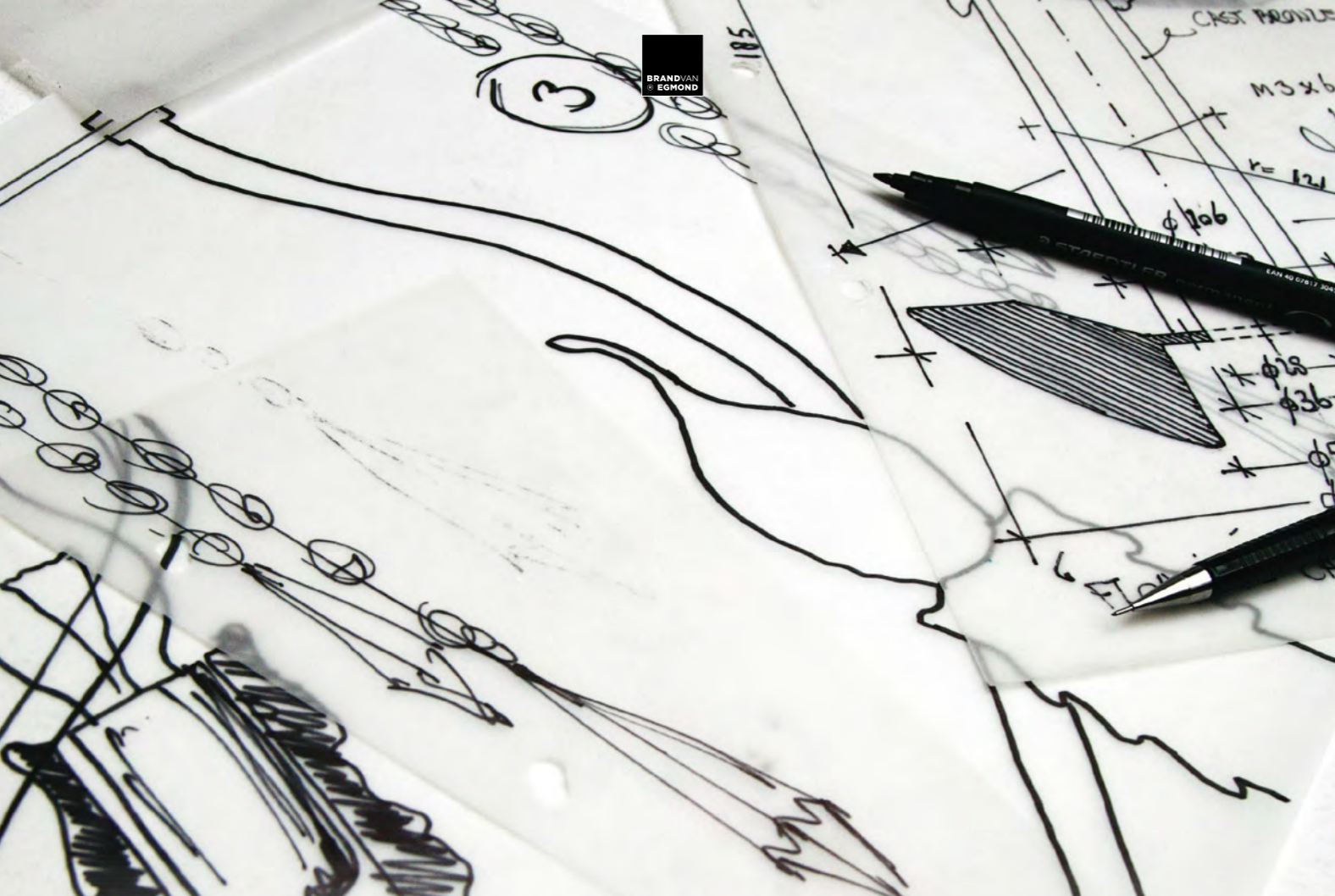

William Brand

designer / owner

William was trained as an artist and an architect. He graduated at the Utrecht School of Arts.

As an award-winning furniture designer he for many years designed buildings and interiors for fashion brands, including the headquarters of BRAND VAN EGMOND. His interior designs are always minimalist, in contrast to his lighting designs which have a powerful sculptural presence. He considers his lighting objects to be “the cherry on the cake”. His way of working is quite specific. Immediately after defining the concept he starts working in the workshop like a sculptor; experimenting and crafting while having the object grow in his hands, often with unexpected results. Therefore the journey is just as exciting and important as the destination.





Architects and other co-creatives are invited to discover the endless possibilities of customising our lighting sculptures.

We hope to inspire you through the different colours and forms of various compositions, just as we enjoy being stimulated by your requests. William Brand's background in architecture gives him the insight to fully understand the demands and challenges of your work. Combined with his experience he is the perfect partner to translate your needs into handcrafted reality.

For our clients we not only customise to different dimensions, but also in different finishes: allowing for a truly personal lighting sculpture to be created.

The possibilities with our lighting sculptures are, in fact, limitless.

We would like to show some of the new possibilities.

Optional finishes



001
Nickel
(N)



002
Black Matt
(BLM)



003
Black High Gloss
(BL)



004
White Matt
(WM)



005
White High Gloss
(W)

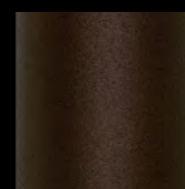

008
Bronze
(B)



010
Brass High Gloss
(BR)



011
Stainless Steel
(ST)



012
Brass Aged
(BRA)*



013
Copper High Gloss
(COP)

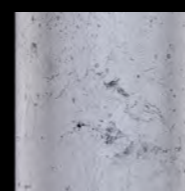

015
Silver Colour leaf
(SL)



016
Gold Colour leaf
(GL)



017
Brass Grinded
(BRG)



019
Brass Burnished
(BRBUR)*



019
Brass Burnished
(BRBUR)*
with nano wax coating



020
Copper Burnished
(COPBUR)*



020
Copper Burnished
(COPBUR)*
with nano wax coating



021
Gold Colour
(GC)

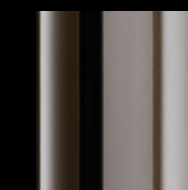

022
Nickel Aged Cool
(NAC)*



023
Brass Aged Colour
(BRAC)



024
Gold Satin
(GSF)



025
Copper Satin
(COPSF)



026
Nickel Aged Warm
(NAW)*

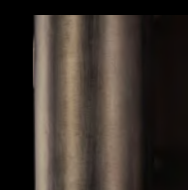

027
Bronze dark patina finish
(BDP)*

* Due to the unique process of creating the finishes Brass Burnished, Brass Aged, Nickel Aged, Copper Burnished and Bronze dark patina finish lights that will be combined in the same space should be ordered at the same time, in order to prevent lights from looking slightly different from each other. Colours and finishes may appear slightly different by viewing in print or on screens.

Technical information

Collection Bella

Chandelier

| Art.nr. | Dimensions | Light bulb | Weight | Finish |
|-----------|-------------|------------|--------|---------------------------|
| BELC75BLM | Ø75xH.90 cm | 4x E27 | 13 kg | black matt finish |
| BELC75BDP | Ø75xH.90 cm | 4x E27 | 13 kg | bronze dark patina finish |
| BELC75N | Ø75xH.90 cm | 4x E27 | 13 kg | nickel finish |
| BELC75GSF | Ø75xH.90 cm | 4x E27 | 13 kg | gold satin finish |

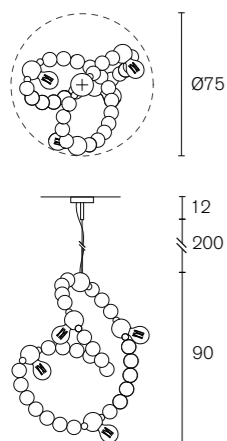

Technical information

Collection Ballet

Hanging Lamp Vertical

| Art.nr. | Dimensions | Light bulb | Weight | Finish |
|-----------|-------------|------------|--------|---------------------------|
| BALV90BDP | Ø70xH.90 cm | 2x E27 | 7 kg | bronze dark patina finish |

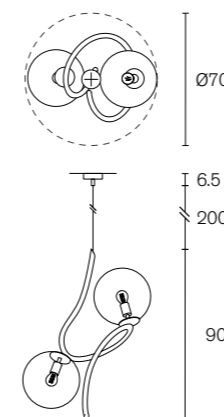

Hanging Lamp Horizontal

| Art.nr. | Dimensions | Light bulb | Weight | Finish |
|-------------|--------------------|------------|--------|---------------------------|
| BALHL140BDP | L.140xW.45xH.50 cm | 2x E27 | 11 kg | bronze dark patina finish |

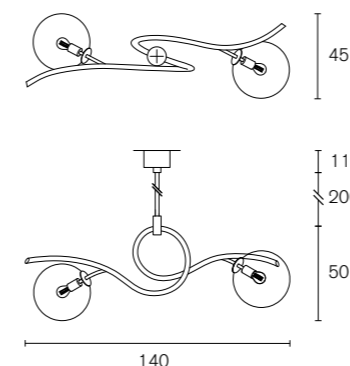

Element

| Art.nr. | Dimensions | Light bulb | Weight | Finish |
|----------|------------|------------|--------|---------------------------|
| BAL25BDP | Ø25 cm | 1x E27 | 2,0 kg | bronze dark patina finish |
| BAL30BDP | Ø30 cm | 1x E27 | 2,5 kg | bronze dark patina finish |
| BAL35BDP | Ø35 cm | 1x E27 | 3,0 kg | bronze dark patina finish |
| BAL40BDP | Ø40 cm | 1x E27 | 3,5 kg | bronze dark patina finish |

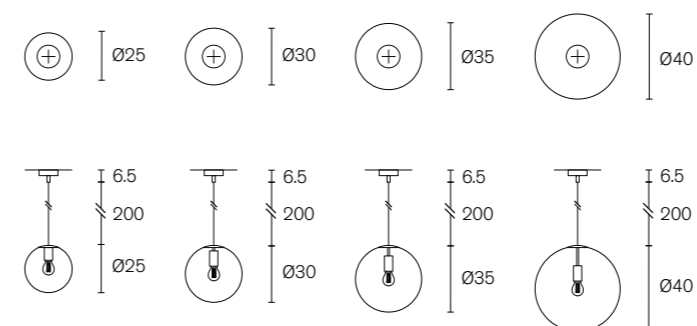

Technical information

Collection Bubbles

Hanging Lamp

| Art.nr. | Dimensions | Light bulb | Weight | Finish |
|-------------|-------------|------------|--------|---------------------------|
| BUBH55BLM | Ø55xH.60 cm | 1x E27 | 2,5 kg | black matt finish |
| BUBH55BDP | Ø55xH.60 cm | 1x E27 | 2,5 kg | bronze dark patina finish |
| BUBH55N | Ø55xH.60 cm | 1x E27 | 2,5 kg | nickel finish |
| BUBH55BRBUR | Ø55xH.60 cm | 1x E27 | 2,5 kg | brass burnished finish |
| BUBH55GSF | Ø55xH.60 cm | 1x E27 | 2,5 kg | gold satin finish |

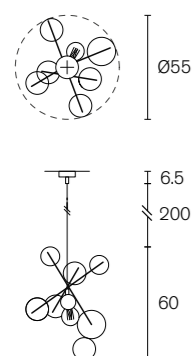

Chandelier

| Art.nr. | Dimensions | Light bulb | Weight | Finish |
|-------------|-------------|------------|--------|---------------------------|
| BUBC75BLM | Ø75xH.50 cm | 3x E27 | 5,5 kg | black matt finish |
| BUBC75BDP | Ø75xH.50 cm | 3x E27 | 5,5 kg | bronze dark patina finish |
| BUBC75N | Ø75xH.50 cm | 3x E27 | 5,5 kg | nickel finish |
| BUBC75BRBUR | Ø75xH.50 cm | 3x E27 | 5,5 kg | brass burnished finish |
| BUBC75GSF | Ø75xH.50 cm | 3x E27 | 5,5 kg | gold satin finish |
| BUBC90BLM | Ø90xH.65 cm | 5x E27 | 8 kg | black matt finish |
| BUBC90BDP | Ø90xH.65 cm | 5x E27 | 8 kg | bronze dark patina finish |
| BUBC90N | Ø90xH.65 cm | 5x E27 | 8 kg | nickel finish |
| BUBC90BRBUR | Ø90xH.65 cm | 5x E27 | 8 kg | brass burnished finish |
| BUBC90GSF | Ø90xH.65 cm | 5x E27 | 8 kg | gold satin finish |

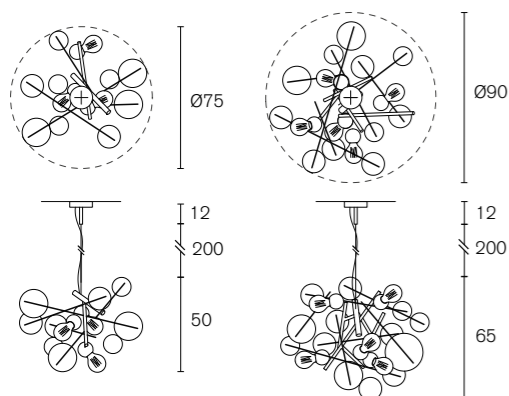

Technical information

Collection Bubbles

Hanging Lamp Long

| Art.nr. | Dimensions | Light bulb | Weight | Finish |
|---------------|--------------------|------------|--------|---------------------------|
| BUBHL140BLM | L.140xW.50xH.40 cm | 5x E27 | 9 kg | black matt finish |
| BUBHL140BDP | L.140xW.50xH.40 cm | 5x E27 | 9 kg | bronze dark patina finish |
| BUBHL140N | L.140xW.50xH.40 cm | 5x E27 | 9 kg | nickel finish |
| BUBHL140BRBUR | L.140xW.50xH.40 cm | 5x E27 | 9 kg | brass burnished finish |
| BUBHL140GSF | L.140xW.50xH.40 cm | 5x E27 | 9 kg | gold satin finish |

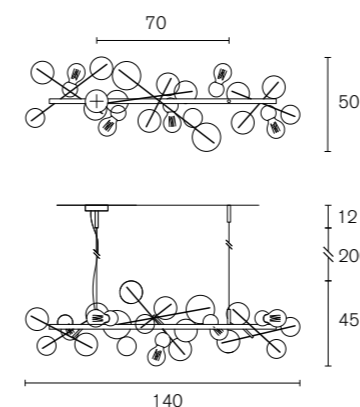

Technical information

Collection Bubbles Flow

Chandelier Conical

| Art.nr. | Dimensions | Light bulb | Weight | Finish |
|-------------|--------------|------------|--------|---------------------------|
| BUBFCC70BDP | Ø70xH.100 cm | 4x E27 | 8 kg | bronze dark patina finish |
| BUBFCC80BDP | Ø80xH.120 cm | 5x E27 | 11 kg | bronze dark patina finish |
| BUBFCC90BDP | Ø90xH.140 cm | 6x E27 | 15 kg | bronze dark patina finish |

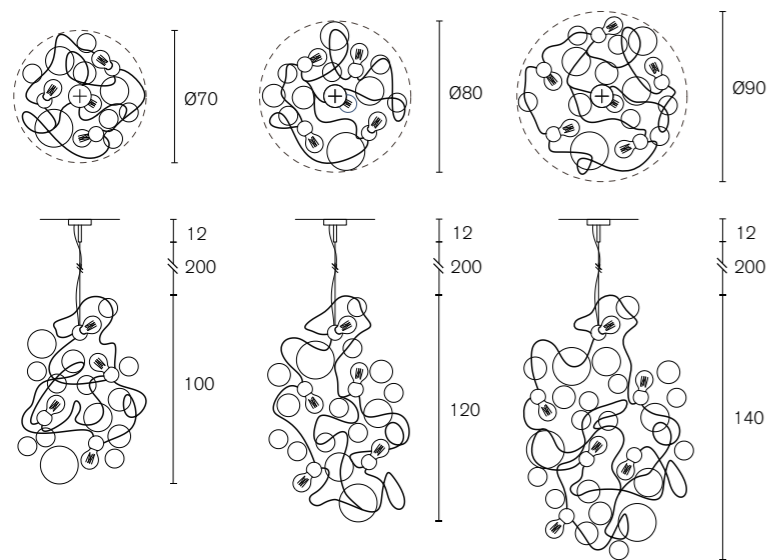

Chandelier Round

| Art.nr. | Dimensions | Light bulb | Weight | Finish |
|-------------|--------------|------------|--------|---------------------------|
| BUBFC80BDP | Ø80xH.50 cm | 4x E27 | 8 kg | bronze dark patina finish |
| BUBFC100BDP | Ø100xH.60 cm | 5x E27 | 12 kg | bronze dark patina finish |
| BUBFC120BDP | Ø120xH.70 cm | 6x E27 | 16 kg | bronze dark patina finish |

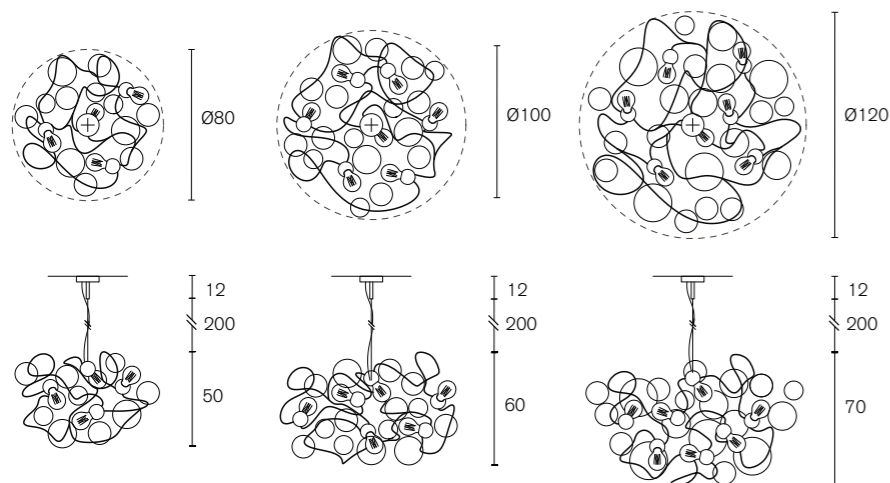

Technical information

Hanging Lamp

| Art.nr. | Dimensions | Light bulb | Weight | Finish |
|------------|-------------|------------|--------|---------------------------|
| BUBFH60BDP | Ø60xH.40 cm | 3x E27 | 5 kg | bronze dark patina finish |

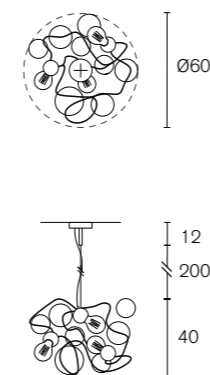

Ceiling Lamp

| Art.nr. | Dimensions | Light bulb | Weight | Finish |
|------------|-------------|------------|--------|---------------------------|
| BUBFP65BDP | Ø65xH.35 cm | 3x E27 | 6 kg | bronze dark patina finish |
| BUBFP90BDP | Ø90xH.35 cm | 5x E27 | 10 kg | bronze dark patina finish |

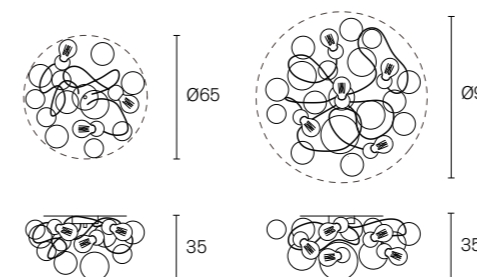

Technical information

Collection Bubbles Swirl

Sculptural Object

| Art.nr. | Dimensions | Light bulb | Weight | Finish |
|---------------|----------------------|------------|--------|---------------------------|
| BUBSOBJ100BDP | W.100xD.80xH.100 cm | 3x E27 | 9 kg | bronze dark patina finish |
| BUBSOBJ130BDP | W.130xD.100xH.150 cm | 5x E27 | 16 kg | bronze dark patina finish |
| BUBSOBJ160BDP | W.160xD.120xH.190 cm | 7x E27 | 22 kg | bronze dark patina finish |

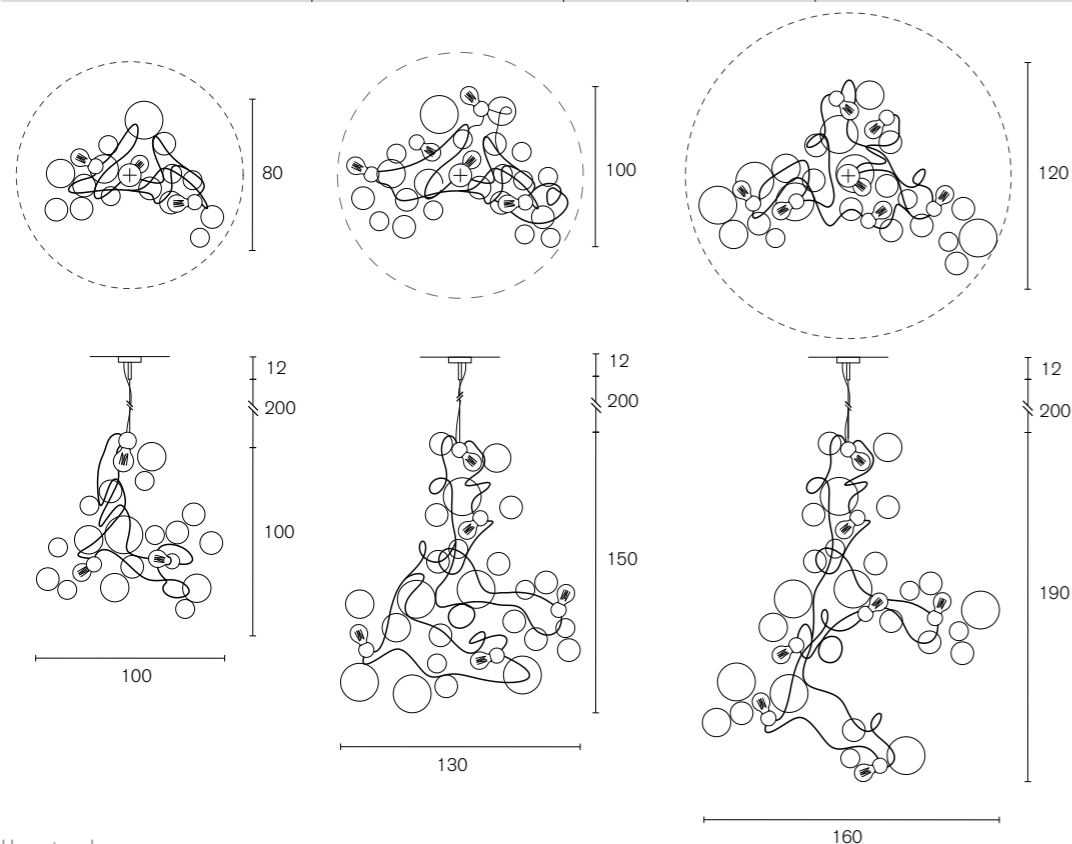

Hanging Lamp

| Art.nr. | Dimensions | Light bulb | Weight | Finish |
|------------|-------------------|------------|--------|---------------------------|
| BUBSH50BDP | W.50xD.40xH.50 cm | 1x E27 | 3 kg | bronze dark patina finish |



For compositions we can offer customised ceiling covers.

Technical information

Collection Solis

Chandelier Conical

| Art.nr. | Dimensions | Light bulb | Weight | Finish |
|-------------------|-------------|------------|---------|--|
| SOLCC70BLM | Ø70xH.80 cm | 12x E14 | 21,0 kg | black matt finish |
| SOLCC70BLM-BDP | Ø70xH.80 cm | 12x E14 | 21,0 kg | black matt finish with bronze dark patina finish finish reflectors |
| SOLCC70BLM-ST | Ø70xH.80 cm | 12x E14 | 21,0 kg | black matt finish with stainless steel reflectors |
| SOLCC70BLM-BR BUR | Ø70xH.80 cm | 12x E14 | 21,0 kg | black matt finish with brass burnished reflectors |
| SOLCC70BLM-GSF | Ø70xH.80 cm | 12x E14 | 21,0 kg | black matt finish with gold satin reflectors |
| SOLCC70BDP-BLM | Ø70xH.80 cm | 12x E14 | 21,0 kg | bronze dark patina finish with black matt reflectors |
| SOLCC70BDP | Ø70xH.80 cm | 12x E14 | 21,0 kg | bronze dark patina finish |
| SOLCC70BDP-ST | Ø70xH.80 cm | 12x E14 | 21,0 kg | bronze dark patina finish with stainless steel reflectors |
| SOLCC70BDP-BR BUR | Ø70xH.80 cm | 12x E14 | 21,0 kg | bronze dark patina finish with brass burnished reflectors |
| SOLCC70BDP-GSF | Ø70xH.80 cm | 12x E14 | 21,0 kg | bronze dark patina finish with gold satin reflectors |

Chandelier Oval

| Art.nr. | Dimensions | Light bulb | Weight | Finish |
|--------------------|--------------------|------------|---------|---|
| SOLOC120BLM | L.120xW.70xH.50 cm | 12x E14 | 20,0 kg | black matt finish |
| SOLOC120BLM-BDP | L.120xW.70xH.50 cm | 12x E14 | 20,0 kg | black matt finish with bronze dark patina finish reflectors |
| SOLOC120BLM-ST | L.120xW.70xH.50 cm | 12x E14 | 20,0 kg | black matt finish with stainless steel reflectors |
| SOLOC120BLM-BR BUR | L.120xW.70xH.50 cm | 12x E14 | 20,0 kg | black matt finish with brass burnished reflectors |
| SOLOC120BLM-GSF | L.120xW.70xH.50 cm | 12x E14 | 20,0 kg | black matt finish with gold satin reflectors |
| SOLOC120BDP-BLM | L.120xW.70xH.50 cm | 12x E14 | 20,0 kg | bronze dark patina finish with black matt reflectors |
| SOLOC120BDP | L.120xW.70xH.50 cm | 12x E14 | 20,0 kg | bronze dark patina finish |
| SOLOC120BDP-ST | L.120xW.70xH.50 cm | 12x E14 | 20,0 kg | bronze dark patina finish with stainless steel reflectors |
| SOLOC120BDP-BR BUR | L.120xW.70xH.50 cm | 12x E14 | 20,0 kg | bronze dark patina finish with brass burnished reflectors |
| SOLOC120BDP-GSF | L.120xW.70xH.50 cm | 12x E14 | 20,0 kg | bronze dark patina finish with gold satin reflectors |



Collection Solis

Chandelier Round

| Art.nr. | Dimensions | Light bulb | Weight | Finish |
|-------------------|--------------|------------|---------|---|
| SOLC100BLM | Ø100xH.55 cm | 12x E14 | 22,0 kg | black matt finish |
| SOLC100BLM-BDP | Ø100xH.55 cm | 12x E14 | 22,0 kg | black matt finish with bronze dark patina finish reflectors |
| SOLC100BLM-ST | Ø100xH.55 cm | 12x E14 | 22,0 kg | black matt finish with stainless steel reflectors |
| SOLC100BLM-BR BUR | Ø100xH.55 cm | 12x E14 | 22,0 kg | black matt finish with brass burnished reflectors |
| SOLC100BLM-GSF | Ø100xH.55 cm | 12x E14 | 22,0 kg | black matt finish with gold satin reflectors |
| SOLC100BDP-BLM | Ø100xH.55 cm | 12x E14 | 22,0 kg | bronze dark patina finish with black matt reflectors |
| SOLC100BDP | Ø100xH.55 cm | 12x E14 | 22,0 kg | bronze dark patina finish |
| SOLC100BDP-ST | Ø100xH.55 cm | 12x E14 | 22,0 kg | bronze dark patina finish with stainless steel reflectors |
| SOLC100BDP-BR BUR | Ø100xH.55 cm | 12x E14 | 22,0 kg | bronze dark patina finish with brass burnished reflectors |
| SOLC100BDP-GSF | Ø100xH.55 cm | 12x E14 | 22,0 kg | bronze dark patina finish with gold satin reflectors |

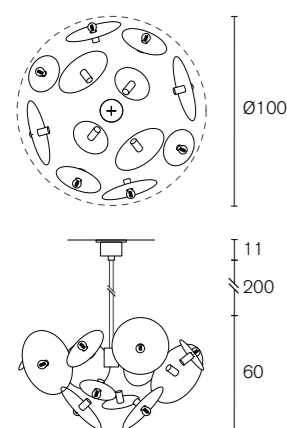

Collection Solis

Hanging Lamp

| Art.nr. | Dimensions | Light bulb | Weight | Finish |
|------------------|-------------|------------|---------|---|
| SOLH40BLM | Ø40xH.30 cm | 5x E14 | 5,0 kg | black matt finish |
| SOLH40BLM-BDP | Ø40xH.30 cm | 5x E14 | 5,0 kg | black matt finish with bronze dark patina finish reflectors |
| SOLH40BLM-ST | Ø40xH.30 cm | 5x E14 | 5,0 kg | black matt finish with stainless steel reflectors |
| SOLH40BLM-BR BUR | Ø40xH.30 cm | 5x E14 | 5,0 kg | black matt finish with brass burnished reflectors |
| SOLH40BLM-GSF | Ø40xH.30 cm | 5x E14 | 5,0 kg | black matt finish with gold satin reflectors |
| SOLH40BDP-BLM | Ø40xH.30 cm | 5x E14 | 5,0 kg | bronze dark patina finish with black matt reflectors |
| SOLH40BDP | Ø40xH.30 cm | 5x E14 | 5,0 kg | bronze dark patina finish |
| SOLH40BDP-ST | Ø40xH.30 cm | 5x E14 | 5,0 kg | bronze dark patina finish with stainless steel reflectors |
| SOLH40BDP-BR BUR | Ø40xH.30 cm | 5x E14 | 5,0 kg | bronze dark patina finish with brass burnished reflectors |
| SOLH40BDP-GSF | Ø40xH.30 cm | 5x E14 | 5,0 kg | bronze dark patina finish with gold satin reflectors |
| SOLH55BLM | Ø55xH.40 cm | 5x E14 | 7,0 kg | black matt finish |
| SOLH55BLM-BDP | Ø55xH.40 cm | 5x E14 | 7,0 kg | black matt finish with bronze dark patina finish reflectors |
| SOLH55BLM-ST | Ø55xH.40 cm | 5x E14 | 7,0 kg | black matt finish with stainless steel reflectors |
| SOLH55BLM-BR BUR | Ø55xH.40 cm | 5x E14 | 7,0 kg | black matt finish with brass burnished reflectors |
| SOLH55BLM-GSF | Ø55xH.40 cm | 5x E14 | 7,0 kg | black matt finish with gold satin reflectors |
| SOLH55BDP-BLM | Ø55xH.40 cm | 5x E14 | 7,0 kg | bronze dark patina finish with black matt reflectors |
| SOLH55BDP | Ø55xH.40 cm | 5x E14 | 7,0 kg | bronze dark patina finish |
| SOLH55BDP-ST | Ø55xH.40 cm | 5x E14 | 7,0 kg | bronze dark patina finish with stainless steel reflectors |
| SOLH55BDP-BR BUR | Ø55xH.40 cm | 5x E14 | 7,0 kg | bronze dark patina finish with brass burnished reflectors |
| SOLH55BDP-GSF | Ø55xH.40 cm | 5x E14 | 7,0 kg | bronze dark patina finish with gold satin reflectors |
| SOLH65BLM | Ø65xH.40 cm | 6x E14 | 10,0 kg | black matt finish |
| SOLH65BLM-BDP | Ø65xH.40 cm | 6x E14 | 10,0 kg | black matt finish with bronze dark patina finish reflectors |
| SOLH65BLM-ST | Ø65xH.40 cm | 6x E14 | 10,0 kg | black matt finish with stainless steel reflectors |
| SOLH65BLM-BR BUR | Ø65xH.40 cm | 6x E14 | 10,0 kg | black matt finish with brass burnished reflectors |
| SOLH65BLM-GSF | Ø65xH.40 cm | 6x E14 | 10,0 kg | black matt finish with gold satin reflectors |
| SOLH65BDP-BLM | Ø65xH.40 cm | 6x E14 | 10,0 kg | bronze dark patina finish with black matt reflectors |
| SOLH65BDP | Ø65xH.40 cm | 6x E14 | 10,0 kg | bronze dark patina finish |
| SOLH65BDP-ST | Ø65xH.40 cm | 6x E14 | 10,0 kg | bronze dark patina finish with stainless steel reflectors |
| SOLH65BDP-BR BUR | Ø65xH.40 cm | 6x E14 | 10,0 kg | bronze dark patina finish with brass burnished reflectors |
| SOLH65BDP-GSF | Ø65xH.40 cm | 6x E14 | 10,0 kg | bronze dark patina finish with gold satin reflectors |

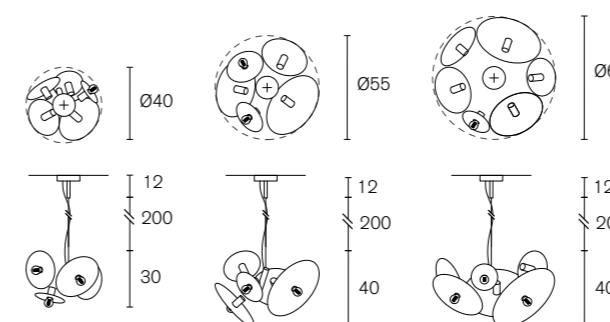

Collection Solis

Hanging Lamp Long

| Art.nr. | Dimensions | Light bulb | Weight | Finish |
|--------------------|--------------------|------------|---------|---|
| SOLHL125BLM | L.125xW.45xH.40 cm | 12x E14 | 15,5 kg | black matt finish |
| SOLHL125BLM-BDP | L.125xW.45xH.40 cm | 12x E14 | 15,5 kg | black matt finish with bronze dark patina finish reflectors |
| SOLHL125BLM-ST | L.125xW.45xH.40 cm | 12x E14 | 15,5 kg | black matt finish with stainless steel reflectors |
| SOLHL125BLM-BR BUR | L.125xW.45xH.40 cm | 12x E14 | 15,5 kg | black matt finish with brass burnished reflectors |
| SOLHL125BLM-GSF | L.125xW.45xH.40 cm | 12x E14 | 15,5 kg | black matt finish with gold satin reflectors |
| SOLHL125BDP-BLM | L.125xW.45xH.40 cm | 12x E14 | 15,5 kg | bronze dark patina finish with black matt reflectors |
| SOLHL125BDP | L.125xW.45xH.40 cm | 12x E14 | 15,5 kg | bronze dark patina finish |
| SOLHL125BDP-ST | L.125xW.45xH.40 cm | 12x E14 | 15,5 kg | bronze dark patina finish with stainless steel reflectors |
| SOLHL125BDP-BR BUR | L.125xW.45xH.40 cm | 12x E14 | 15,5 kg | bronze dark patina finish with brass burnished reflectors |
| SOLHL125BDP-GSF | L.125xW.45xH.40 cm | 12x E14 | 15,5 kg | bronze dark patina finish with gold satin reflectors |

Hanging Lamp Vertical

| Art.nr. | Dimensions | Light bulb | Weight | Finish |
|-------------------|--------------|------------|--------|---|
| SOLV150BLM | Ø50xH.150 cm | 14x E14 | 17 kg | black matt finish |
| SOLV150BLM-BDP | Ø50xH.150 cm | 14x E14 | 17 kg | black matt finish with bronze dark patina finish reflectors |
| SOLV150BLM-ST | Ø50xH.150 cm | 14x E14 | 17 kg | black matt finish with stainless steel reflectors |
| SOLV150BLM-BR BUR | Ø50xH.150 cm | 14x E14 | 17 kg | black matt finish with brass burnished reflectors |
| SOLV150BLM-GSF | Ø50xH.150 cm | 14x E14 | 17 kg | black matt finish with gold satin reflectors |
| SOLV150BDP-BLM | Ø50xH.150 cm | 14x E14 | 17 kg | bronze dark patina finish with black matt reflectors |
| SOLV150BDP | Ø50xH.150 cm | 14x E14 | 17 kg | bronze dark patina finish |
| SOLV150BDP-ST | Ø50xH.150 cm | 14x E14 | 17 kg | bronze dark patina finish with stainless steel reflectors |
| SOLV150BDP-BR BUR | Ø50xH.150 cm | 14x E14 | 17 kg | bronze dark patina finish with brass burnished reflectors |
| SOLV150BDP-GSF | Ø50xH.150 cm | 14x E14 | 17 kg | bronze dark patina finish with gold satin reflectors |

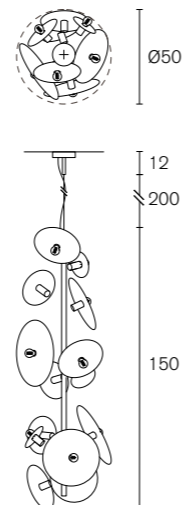
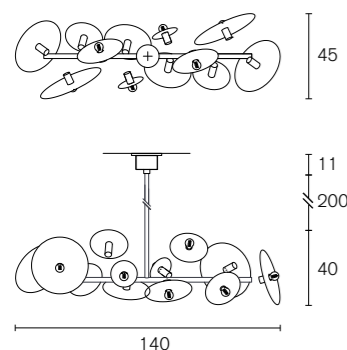

Collection Solis

Ceiling Lamp

| Art.nr. | Dimensions | Light bulb | Weight | Finish |
|------------------|-------------|------------|--------|---|
| SOLP35BLM | Ø35xH.20 cm | 3x E14 | 5 kg | black matt finish |
| SOLP35BLM-BDP | Ø35xH.20 cm | 3x E14 | 5 kg | black matt finish with bronze dark patina finish reflectors |
| SOLP35BLM-ST | Ø35xH.20 cm | 3x E14 | 5 kg | black matt finish with stainless steel reflectors |
| SOLP35BLM-BR BUR | Ø35xH.20 cm | 3x E14 | 5 kg | black matt finish with brass burnished reflectors |
| SOLP35BLM-GSF | Ø35xH.20 cm | 3x E14 | 5 kg | black matt finish with gold satin reflectors |
| SOLP35BDP-BLM | Ø35xH.20 cm | 3x E14 | 5 kg | bronze dark patina finish with black matt reflectors |
| SOLP35BDP | Ø35xH.20 cm | 3x E14 | 5 kg | bronze dark patina finish |
| SOLP35BDP-ST | Ø35xH.20 cm | 3x E14 | 5 kg | bronze dark patina finish with stainless steel reflectors |
| SOLP35BDP-BR BUR | Ø35xH.20 cm | 3x E14 | 5 kg | bronze dark patina finish with brass burnished reflectors |
| SOLP35BDP-GSF | Ø35xH.20 cm | 3x E14 | 5 kg | bronze dark patina finish with gold satin reflectors |
| SOLP65BLM | Ø65xH.25 cm | 5x E14 | 8 kg | black matt finish |
| SOLP65BLM-BDP | Ø65xH.25 cm | 5x E14 | 8 kg | black matt finish with bronze dark patina finish reflectors |
| SOLP65BLM-ST | Ø65xH.25 cm | 5x E14 | 8 kg | black matt finish with stainless steel reflectors |
| SOLP65BLM-BR BUR | Ø65xH.25 cm | 5x E14 | 8 kg | black matt finish with brass burnished reflectors |
| SOLP65BLM-GSF | Ø65xH.25 cm | 5x E14 | 8 kg | black matt finish with gold satin reflectors |
| SOLP65BDP-BLM | Ø65xH.25 cm | 5x E14 | 8 kg | bronze dark patina finish with black matt reflectors |
| SOLP65BDP | Ø65xH.25 cm | 5x E14 | 8 kg | bronze dark patina finish |
| SOLP65BDP-ST | Ø65xH.25 cm | 5x E14 | 8 kg | bronze dark patina finish with stainless steel reflectors |
| SOLP65BDP-BR BUR | Ø65xH.25 cm | 5x E14 | 8 kg | bronze dark patina finish with brass burnished reflectors |
| SOLP65BDP-GSF | Ø65xH.25 cm | 5x E14 | 8 kg | bronze dark patina finish with gold satin reflectors |
| SOLP90BLM | Ø90xH.25 cm | 5x E14 | 10 kg | black matt finish |
| SOLP90BLM-BDP | Ø90xH.25 cm | 5x E14 | 10 kg | black matt finish with bronze dark patina finish reflectors |
| SOLP90BLM-ST | Ø90xH.25 cm | 5x E14 | 10 kg | black matt finish with stainless steel reflectors |
| SOLP90BLM-BR BUR | Ø90xH.25 cm | 5x E14 | 10 kg | black matt finish with brass burnished reflectors |
| SOLP90BLM-GSF | Ø90xH.25 cm | 5x E14 | 10 kg | black matt finish with gold satin reflectors |
| SOLP90BDP-BLM | Ø90xH.25 cm | 5x E14 | 10 kg | bronze dark patina finish with black matt reflectors |
| SOLP90BDP | Ø90xH.25 cm | 5x E14 | 10 kg | bronze dark patina finish |
| SOLP90BDP-ST | Ø90xH.25 cm | 5x E14 | 10 kg | bronze dark patina finish with stainless steel reflectors |
| SOLP90BDP-BR BUR | Ø90xH.25 cm | 5x E14 | 10 kg | bronze dark patina finish with brass burnished reflectors |
| SOLP90BDP-GSF | Ø90xH.25 cm | 5x E14 | 10 kg | bronze dark patina finish with gold satin reflectors |

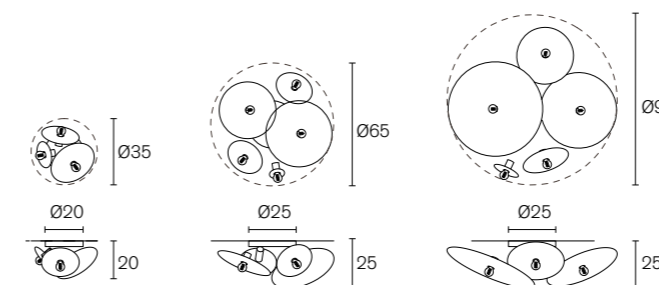

also available as Solis wall lights

Collection Solis

Floor Lamp

| Art.nr. | Dimensions | Light bulb | Weight | Finish |
|-------------------|--------------|------------|--------|---|
| SOLF200BLM | Ø50xH.200 cm | 7x E14 | 27 kg | black matt finish |
| SOLF200BLM-BDP | Ø50xH.200 cm | 7x E14 | 27 kg | black matt finish with bronze dark patina finish reflectors |
| SOLF200BLM-ST | Ø50xH.200 cm | 7x E14 | 27 kg | black matt finish with stainless steel reflectors |
| SOLF200BLM-BR BUR | Ø50xH.200 cm | 7x E14 | 27 kg | black matt finish with brass burnished reflectors |
| SOLF200BLM-GSF | Ø50xH.200 cm | 7x E14 | 27 kg | black matt finish with gold satin reflectors |
| SOLF200BDP-BLM | Ø50xH.200 cm | 7x E14 | 27 kg | bronze dark patina finish with black matt reflectors |
| SOLF200BDP | Ø50xH.200 cm | 7x E14 | 27 kg | bronze dark patina finish |
| SOLF200BDP-ST | Ø50xH.200 cm | 7x E14 | 27 kg | bronze dark patina finish with stainless steel reflectors |
| SOLF200BDP-BR BUR | Ø50xH.200 cm | 7x E14 | 27 kg | bronze dark patina finish with brass burnished reflectors |
| SOLF200BDP-GSF | Ø50xH.200 cm | 7x E14 | 27 kg | bronze dark patina finish with gold satin reflectors |

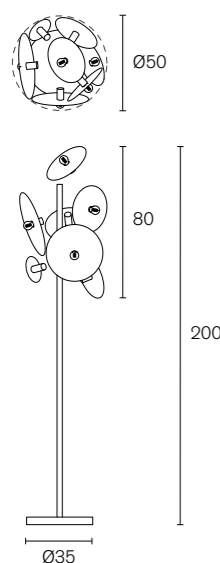

Collection Solis

Table Lamp

| Art.nr. | Dimensions | Light bulb | Weight | Finish |
|------------------|-------------|------------|--------|---|
| SOLT75BLM | Ø40xH.75 cm | 5x E14 | 10 kg | black matt finish |
| SOLT75BLM-BDP | Ø40xH.75 cm | 5x E14 | 10 kg | black matt finish with bronze dark patina finish reflectors |
| SOLT75BLM-ST | Ø40xH.75 cm | 5x E14 | 10 kg | black matt finish with stainless steel reflectors |
| SOLT75BLM-BR BUR | Ø40xH.75 cm | 5x E14 | 10 kg | black matt finish with brass burnished reflectors |
| SOLT75BLM-GSF | Ø40xH.75 cm | 5x E14 | 10 kg | black matt finish with gold satin reflectors |
| SOLT75BDP-BLM | Ø40xH.75 cm | 5x E14 | 10 kg | bronze dark patina finish with black matt reflectors |
| SOLT75BDP | Ø40xH.75 cm | 5x E14 | 10 kg | bronze dark patina finish |
| SOLT75BDP-ST | Ø40xH.75 cm | 5x E14 | 10 kg | bronze dark patina finish with stainless steel reflectors |
| SOLT75BDP-BR BUR | Ø40xH.75 cm | 5x E14 | 10 kg | bronze dark patina finish with brass burnished reflectors |
| SOLT75BDP-GSF | Ø40xH.75 cm | 5x E14 | 10 kg | bronze dark patina finish with gold satin reflectors |

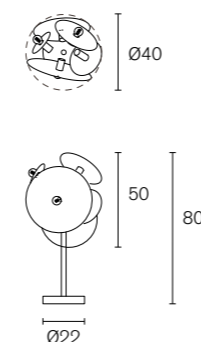

Collection Solis

Wall Lamp

| Art.nr. | Dimensions | Light bulb | Weight | Finish |
|------------------|-------------|------------|--------|---|
| SOLW35BLM | Ø35xH.20 cm | 3x E14 | 5 kg | black matt finish |
| SOLW35BLM-BDP | Ø35xH.20 cm | 3x E14 | 5 kg | black matt finish with bronze dark patina finish reflectors |
| SOLW35BLM-ST | Ø35xH.20 cm | 3x E14 | 5 kg | black matt finish with stainless steel reflectors |
| SOLW35BLM-BR BUR | Ø35xH.20 cm | 3x E14 | 5 kg | black matt finish with brass burnished reflectors |
| SOLW35BLM-GSF | Ø35xH.20 cm | 3x E14 | 5 kg | black matt finish with gold satin reflectors |
| SOLW35BDP-BLM | Ø35xH.20 cm | 3x E14 | 5 kg | bronze dark patina finish with black matt reflectors |
| SOLW35BDP | Ø35xH.20 cm | 3x E14 | 5 kg | bronze dark patina finish |
| SOLW35BDP-ST | Ø35xH.20 cm | 3x E14 | 5 kg | bronze dark patina finish with stainless steel reflectors |
| SOLW35BDP-BR BUR | Ø35xH.20 cm | 3x E14 | 5 kg | bronze dark patina finish with brass burnished reflectors |
| SOLW35BDP-GSF | Ø35xH.20 cm | 3x E14 | 5 kg | bronze dark patina finish with gold satin reflectors |

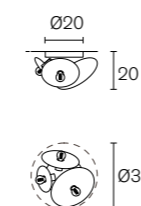

Technical information

Collection Primavera

Chandelier

| Art.nr. | Dimensions | Light bulb | Weight | Finish |
|-------------|--------------|------------|---------|---------------------------|
| PRIC60BLM | Ø60xH.92 cm | 6x G9 | 13,5 kg | black matt finish |
| PRIC60WM | Ø60xH.92 cm | 6x G9 | 13,5 kg | white matt finish |
| PRIC60BDP | Ø60xH.92 cm | 6x G9 | 13,5 kg | bronze dark patina finish |
| PRIC60BRBUR | Ø60xH.92 cm | 6x G9 | 13,5 kg | brass burnished finish |
| PRIC60GSF | Ø60xH.92 cm | 6x G9 | 13,5 kg | gold satin finish |
| PRIC90BLM | Ø90xH.107 cm | 12x G9 | 25 kg | black matt finish |
| PRIC90WM | Ø90xH.107 cm | 12x G9 | 25 kg | white matt finish |
| PRIC90BDP | Ø90xH.107 cm | 12x G9 | 25 kg | bronze dark patina finish |
| PRIC90BRBUR | Ø90xH.107 cm | 12x G9 | 25 kg | brass burnished finish |
| PRIC90GSF | Ø90xH.107 cm | 12x G9 | 25 kg | gold satin finish |

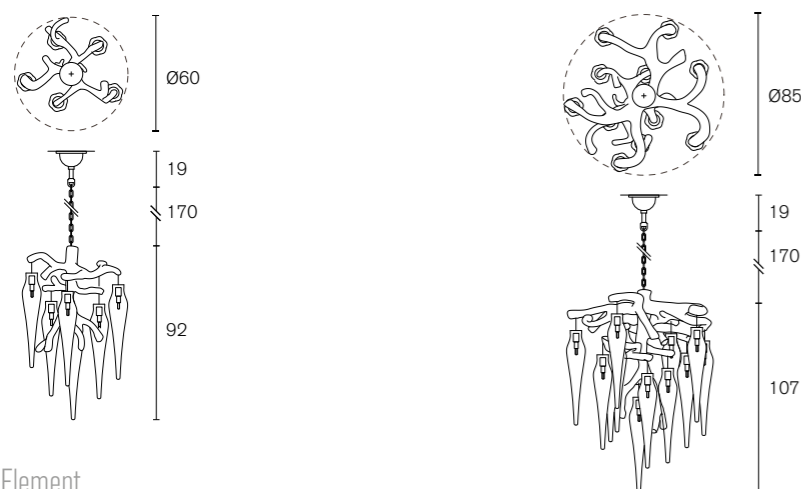

Element

| Art.nr. | Dimensions | Light bulb | Weight | Finish |
|------------|-------------|------------|--------|---------------------------|
| PRI30BLM | Ø30xH.80 cm | 3x G9 | 4,5 kg | black matt finish |
| PRI30WM | Ø30xH.80 cm | 3x G9 | 4,5 kg | white matt finish |
| PRI30BDP | Ø30xH.80 cm | 3x G9 | 4,5 kg | bronze dark patina finish |
| PRI30BRBUR | Ø30xH.80 cm | 3x G9 | 4,5 kg | brass burnished finish |
| PRI30GSF | Ø30xH.80 cm | 3x G9 | 4,5 kg | gold satin finish |

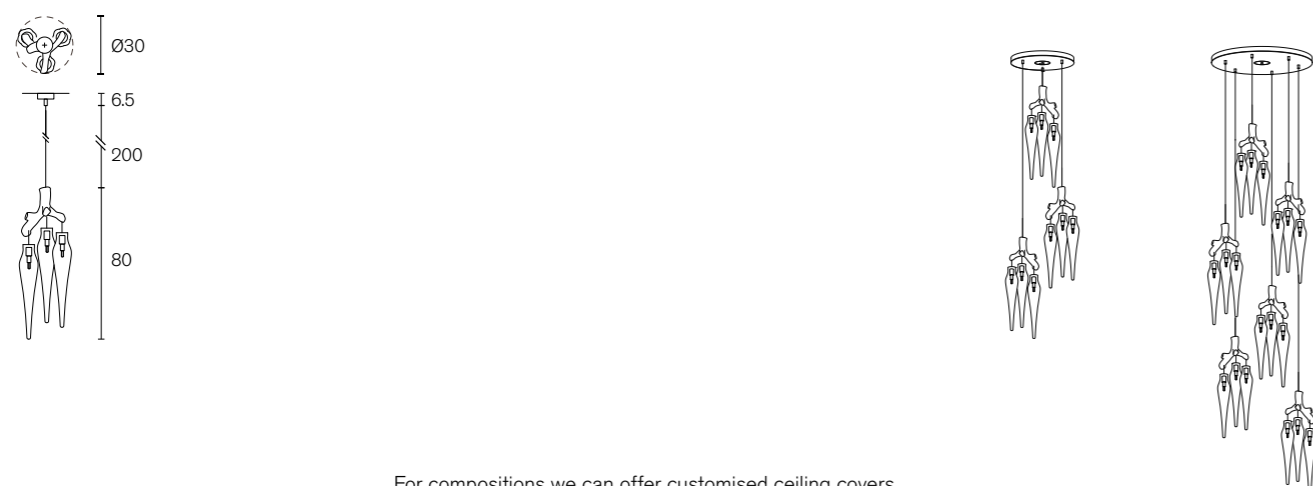

For compositions we can offer customised ceiling covers.

Technical information

Collection Primavera

Wall light

| Art.nr. | Dimensions | Light bulb | Weight | Finish |
|-------------|-------------------|------------|--------|---------------------------|
| PRIW50BLM | W.10xH.52xD.17 cm | 1x G9 | 4 kg | black matt finish |
| PRIW50WM | W.10xH.52xD.17 cm | 1x G9 | 4 kg | white matt finish |
| PRIW50BDP | W.10xH.52xD.17 cm | 1x G9 | 4 kg | bronze dark patina finish |
| PRIW50BRBUR | W.10xH.52xD.17 cm | 1x G9 | 4 kg | brass burnished finish |
| PRIW50GSF | W.10xH.52xD.17 cm | 1x G9 | 4 kg | gold satin finish |

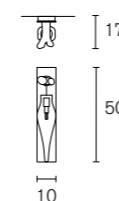

Collection Primavera Icicles

Element

| Art.nr. | Dimensions | Light bulb | Weight | Finish |
|----------|-------------|------------|--------|---------------|
| PRIS135N | Ø10xH.35 cm | 1x G9 | 1 kg | nickel finish |
| PRIS150N | Ø10xH.50 cm | 1x G9 | 1 kg | nickel finish |

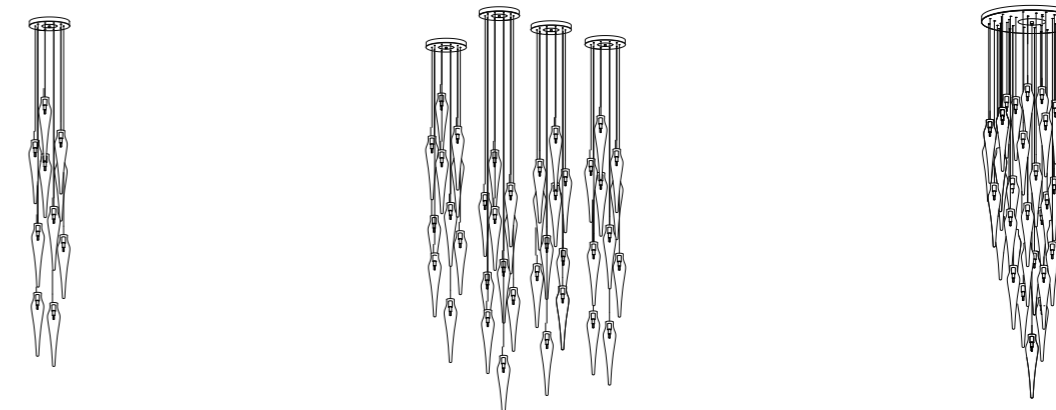
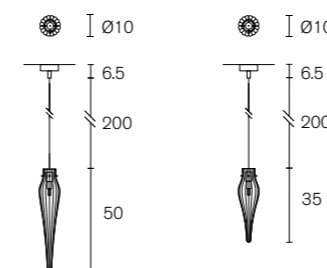

For compositions we can offer customised ceiling covers.

Technical information

Collection Desert Wind

Chandelier Conical

| Art.nr. | Dimensions | Light bulb | Weight | Finish |
|------------|-------------|------------|--------|-------------------|
| DEWCC80BLM | Ø80xH.80 cm | 9x E14 | 22 kg | black matt finish |
| DEWCC80GSF | Ø80xH.80 cm | 9x E14 | 22 kg | gold satin finish |

Chandelier Oval

| Art.nr. | Dimensions | Light bulb | Weight | Finish |
|-------------|--------------------|------------|--------|-------------------|
| DEWOC140BLM | L.140xW.65xH.55 cm | 10x E14 | 27 kg | black matt finish |
| DEWOC140GSF | L.140xW.65xH.55 cm | 10x E14 | 27 kg | gold satin finish |

Chandelier Round

| Art.nr. | Dimensions | Light bulb | Weight | Finish |
|------------|--------------|------------|--------|-------------------|
| DEWC125BLM | Ø125xH.55 cm | 11x E14 | 25 kg | black matt finish |
| DEWC125GSF | Ø125xH.55 cm | 11x E14 | 25 kg | gold satin finish |

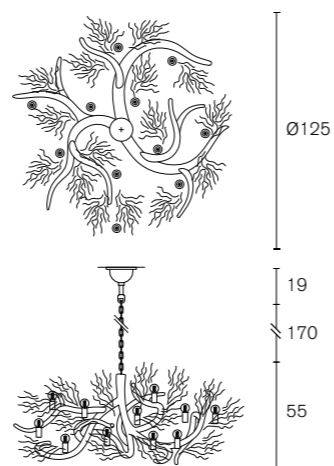
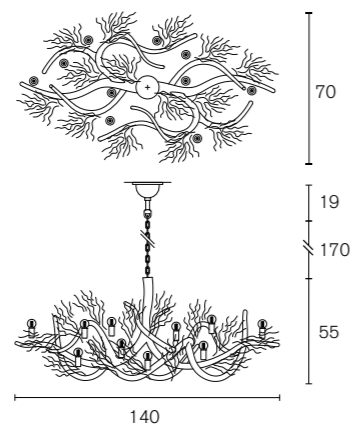
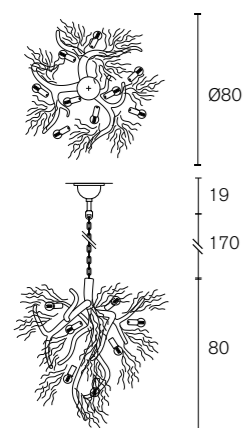

Technical information

Collection Takara

Hanging Lamp Long

| Art.nr. | Dimensions | Light bulb | Weight | Finish |
|-------------|--------------------|------------------------|--------|-------------------------|
| TAKHL150BDP | L.142xW.12xH.14 cm | 2x LED STRIPE L. 100CM | 21 kg | cast bronze dark patina |
| TAKHL200BDP | L.194xW.18xH.14 cm | 2x LED STRIPE L. 150CM | 27 kg | cast bronze dark patina |

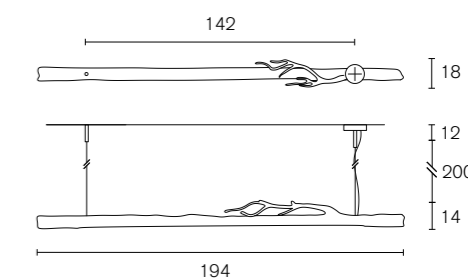
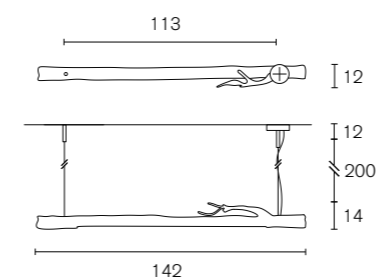

General Terms and Conditions of Sales

1. Applicability of terms and Conditions of Sales

- 1.1 These general conditions of sales and delivery shall apply to all offers, quotes, deliveries, services and agreements of Brand van Egmond B.V. ("BRAND VAN EGMOND").
- 1.2 All orders are accepted and executed by BRAND VAN EGMOND subject to and in accordance with the following conditions of sales which override and exclude any other terms stipulated or incorporated or referred to by the customer during any negotiations or in any course of dealing between BRAND VAN EGMOND and the customer.
- 1.3 No variation or deviation to these conditions of sales is permitted unless expressly authorised in writing by a director of BRAND VAN EGMOND.

2. Quotations and orders

- 2.1 Subject to the terms contained in this section, any quotation provided by BRAND VAN EGMOND will be without engagement.
- 2.2 Although BRAND VAN EGMOND strives to provide accurate product and pricing information, errors or misprints may occur. BRAND VAN EGMOND cannot confirm the price of a product until after the customer orders the product. Notwithstanding anything contained in this section, in the event that a product is listed at an incorrect price or with incorrect information due to an error in pricing or product information, BRAND VAN EGMOND shall have the right, at its sole discretion, to refuse or cancel any orders placed for that product. In the event that a product is priced in error or a product information error occurs, BRAND VAN EGMOND may, at its sole discretion, either contact the customer for instructions, cancel the order and notify the customer of such cancellation, and/or correct the error on its web site/pricelist, any without liability.
- 2.3 Orders are not binding on BRAND VAN EGMOND until accepted by BRAND VAN EGMOND. BRAND VAN EGMOND's acceptance of an order is evidenced in writing including return e-mail from BRAND VAN EGMOND indicating that customer's order has been accepted.
- 2.4 Changes of orders will be accepted up to 3 (three) days only from our order confirmation.
- 2.5 The cancellation of a confirmed order is valid only if it is accepted in writing by BRAND VAN EGMOND. Expenses due to cancellation will be charged.

3. Prices

- 3.1 Prices for products are in EUR and exclusive of VAT, unless otherwise indicated.
- 3.2 BRAND VAN EGMOND reserves the right to increase prices after execution of the agreement and without notice at any time in the event that the manufacturing prices of BRAND VAN EGMOND increase.
- 3.3 Unless indicated otherwise in writing by BRAND VAN EGMOND, the prices are based on delivery on the basis of EXW (Ex Works), Naarden, The Netherlands (according to the latest version of the ICC Incoterms®).

4. Payment

- 4.1 Unless credit terms have been agreed to in writing by BRAND VAN EGMOND, customer shall pay invoices within thirty (30) days from the date of the invoices without any deductions or set-off whatsoever.
- 4.2 If payment is not received by BRAND VAN EGMOND by the due date, the customer shall pay a financing charge of 2% of the capital sum for each month or portion thereof during which payment remains outstanding, until payment is made in full.
- 4.3 BRAND VAN EGMOND reserves the right to demand payment up front or to demand security for the payment of the invoices before commencing the production and/or delivery of the products.
- 4.4 If the customer fails to make payment by the due date or fails to provide security without prejudice to any other right or remedy, and without prior notice of default, BRAND VAN EGMOND shall be entitled to: i. cancel the order or suspend any further deliveries; and ii. appropriate any payment made by the customer to such of the products (or the products supplied under any other contract) as BRAND VAN EGMOND may think fit.
- 4.5 All expenses in connection with the recovery of the amounts payable and not paid in time by BRAND VAN EGMOND shall be for the account of the customer. The extrajudicial expenses shall be at least 15% of the amount due, at a minimum of Euro 750, and shall already be payable and claimable as soon as the claim is passed out of hand for collection.

5. Accounts

A customer wishing to open a credit account must furnish such information as requested by BRAND VAN EGMOND and BRAND VAN EGMOND will make a search with a credit reference agency. BRAND VAN EGMOND reserves the right in its absolute discretion to grant, refuse or discontinue any credit facilities or reduce or suspend any credit limit at any time.

6. Product availability; special orders

- 6.1 Product availability may be limited. Products may not be available for immediate delivery. BRAND VAN EGMOND reserves the right, without liability or prior notice, to revise or cease to make available any or all products. All articles shall be executed in standard design.
- 6.2 For an order of deviating models or colours or special requests a surcharge shall be made, this after prior written consultation. All special orders are, unless agreed to otherwise in writing, paid for by the customer upfront.

7. Delivery

- 7.1 Unless agreed otherwise in writing delivery shall take place EXW (Ex Works) Naarden, the Netherlands, according to the latest version of the ICC Incoterms®.
- 7.2 BRAND VAN EGMOND will use reasonable endeavours to meet delivery estimates but in no circumstances shall it be liable to compensate the customer for non-delivery or late delivery.
- 7.3 BRAND VAN EGMOND reserves the right to deliver by instalments or in parts. Failure to meet a delivery date where delivery is by instalments shall not preclude BRAND VAN EGMOND's right to make further deliveries by instalments under the relevant contract.
- 7.4 The customer may request delivery by instalments for a maximum period of 12 months from the date of order.
- 7.5 The risk for the goods to be delivered shall pass to the customer from the moment that they are placed at the disposal of the customer at the premises of BRAND VAN EGMOND unless agreed to otherwise in writing. Any assistance by BRAND VAN EGMOND with the loading of the goods on any means of transportation shall be for the risk of the customer.

- 7.6 If delivery of the goods is refused by the customer, without prejudice to the provisions of article 9, the risk of the goods shall pass to the customer at once and BRAND VAN EGMOND can immediately claim payment. BRAND VAN EGMOND shall keep the goods at the customer's risks and expense until further notice.
- 7.7 If the customer continues to default after being summoned BRAND VAN EGMOND shall be entitled to dispose of the goods or to give them another destination. Any proceeds shall be credited to the customer with deduction of all expenses coming for his account, without prejudice to BRAND VAN EGMOND's right to full payment of the agreed price.

8. Inspection, defects and non-delivery, returns

- 8.1 The customer must inspect the products at the moment of delivery. BRAND VAN EGMOND shall not be liable for any defects in the products unless written notice with a statement of reasons is given to BRAND VAN EGMOND within seven (7) days of receipt. If complaints have not been made in the above mentioned manner and within the aforementioned period of seven (7) days, the delivery shall be considered unconditionally accepted.
- 8.2 The quantity of any consignment of products as recorded by BRAND VAN EGMOND upon despatch from BRAND VAN EGMOND's place of business shall be conclusive evidence of the quantity received by the customer on delivery, unless the customer can provide conclusive evidence to the contrary.
- 8.3 Customary deviations shall not be reasons for complaint. The photos on this web site, in our catalogue and brochures are provided to assist you in choosing the right product. These photos are meant to be samples only and are not intended to provide a perfect match to the actual product color. Colors and photo size may vary based upon your screen resolution and other computer settings outside of our control. The photo may differ from the actual product due to reproduction limitations of the photograph and limitations of viewing photos at different resolutions, hue, brightness, contrast, and other screen variations. Therefore, Brand van Egmond shall not be held responsible for any variation between the photos on this website/catalogue and the actual products you receive, including but not limited to: Color variation, grain variation, color change, and character variation
- 8.4 Any liability of BRAND VAN EGMOND for non-delivery or defective products shall to BRAND VAN EGMOND's discretion be limited to replacing, repairing or making up the products within a reasonable time.
- 8.5 No order can be cancelled or accepted without previous written agreement of BRAND VAN EGMOND.
- 8.6 Products may not be returned without BRAND VAN EGMOND's permission. If BRAND VAN EGMOND agrees to take the Products back, the customer shall obtain a return merchandise authorisation number (RMA number). Any products returned must be provided with the RMA number by the customer and be received by BRAND VAN EGMOND within seven (7) days of delivery and must be complete, undamaged and in original packaging. Products returned after seven (7) days as unwanted or incorrectly ordered will be accepted at the discretion of BRAND VAN EGMOND and will be subject to a restocking fee representing 30% of the invoice value of the products.
- 8.7 Certain products - such as products specially designed or manufactured for the customer - are excluded from any return. The customer is responsible for returning products to BRAND VAN EGMOND and for providing proof of delivery of such return.
- 8.8 Products will be returned at the customer's expense.

9. Retention of title

- 9.1 Ownership of the products shall not pass to the customer until BRAND VAN EGMOND has received in full (in cash or cleared funds) all sums due in respect of the products.
- 9.2 The customer shall not be entitled to alienate or encumber the products in any way as long as full payment has not been made to BRAND VAN EGMOND, except where and in so far as the normal conduct of business is concerned. The customer shall be obliged to pledge to BRAND VAN EGMOND any claims on third parties resulting from this, on pain of a fine to the amount of 50% of the invoice amount for the goods supplied, with a minimum of € 2.250,=.
- 9.3 If payment is not received in full by the due date, or the customer passes a resolution for winding up or a court shall make an order to that effect, or a receiver is appointed over any assets or the undertaking of the customer or an execution or distress is levied against the customer, BRAND VAN EGMOND shall be entitled, without previous notice, to retake possession of the products and for that purpose to enter upon any premises occupied or owned by the customer.

10. Performance and fitness for purpose

- 10.1 Unless any performance figures, tolerances or characteristics have been specifically and expressly warranted by a director of BRAND VAN EGMOND in writing, BRAND VAN EGMOND accepts no liability for any failure of the products to obtain such figures.
- 10.2 The responsibility for ensuring that products are sufficient and suitable for a particular purpose is the customer's, unless specifically stated in writing by a director of BRAND VAN EGMOND.
- 10.3 Any advice or recommendation given by an employee of BRAND VAN EGMOND, which is not confirmed in writing by a director of BRAND VAN EGMOND, is acted on entirely at the customer's risk and BRAND VAN EGMOND and its employees shall not be liable for any such advice or recommendation which is not so confirmed.

11. Guarantee

- 11.1 Each product has been manufactured and packaged to meet BRAND VAN EGMOND's high standards. Any defects which, under proper use, appear in the products within a period of twelve (12) months (unless otherwise stated by BRAND VAN EGMOND) and which are due to faulty materials, workmanship or design will be made good by BRAND VAN EGMOND either by repair, or at BRAND VAN EGMOND's option, replacement (which is BRAND VAN EGMOND's sole obligation and the customer's sole remedy).
- 11.2 BRAND VAN EGMOND's guarantee is accepted by the customer in substitution for all express or implied representations, conditions or warranties, statutory or otherwise, as to the satisfactory quality, fitness for purpose or performance of the products (or any materials used in connection therewith) or the standard of workmanship of any services provided, and all such representations, conditions and warranties are excluded.
- 11.3 BRAND VAN EGMOND shall not be liable for defective products if the defect arises because the customer alters or repairs such products without the written consent of BRAND VAN EGMOND or because the customer did not follow the manufacturers' instructions for storage, usage, installation, use or maintenance of the products.
- 11.4 Any products replaced or repaired under this paragraph will be guaranteed on these terms for any unexpired portion of the guarantee given on the original products.

12. Liability

- 12.1 These conditions of sales set out the entire liability of BRAND VAN EGMOND to the customer in respect of the products and shall be in lieu and to the exclusion of all other warranties, conditions, and other terms implied by statute or common law save for any implied terms which by law cannot be excluded.
- 12.2 Nothing in these conditions of sale excludes or limits the liability of BRAND VAN EGMOND for death or personal injury caused by BRAND VAN EGMOND's negligence or fraudulent misrepresentation.
- 12.3 BRAND VAN EGMOND's total liability in contract, tort (including negligence or breach of statutory duty), misrepresentation or otherwise shall be limited to repairing, replacing or at BRAND VAN EGMOND's option refunding monies already paid in respect of the products.
- 12.4 BRAND VAN EGMOND shall not be liable to the customer for any indirect or consequential loss or damage (whether for loss of profit, loss of business, loss of goodwill or otherwise) costs, expenses or other claims for consequential compensation whatsoever (whether caused by the negligence of BRAND VAN EGMOND, its employees, agents or subcontractors) which arise out or in connection with any contract.
- 12.5 BRAND VAN EGMOND shall not be liable for damage if the customer has not held BRAND VAN EGMOND liable for the damage by registered letter within a reasonable time after becoming aware of the cause of damage, but not later than thirty (30) days after becoming aware of the damage.
- 12.6 All stipulations concerning the exclusion or limitation of BRAND VAN EGMOND's liability for and concerning BRAND VAN EGMOND's indemnity against claims of third parties have also been made for the benefit of the persons who are employed by BRAND VAN EGMOND as well as third parties for whose actions or omissions BRAND VAN EGMOND can be liable.

13. Termination

- 13.1 If the customer is in default with timely payment or fulfilment of other obligations towards BRAND VAN EGMOND, BRAND VAN EGMOND shall remain entitled, without any notice of default, to consider the agreement rescinded, without prejudice to BRAND VAN EGMOND's right to full compensation of damage suffered and to be suffered and any further rights.
- 13.2 The power to rescind the agreement on the strength of article 13.1 shall also be due to BRAND VAN EGMOND if BRAND VAN EGMOND finds that the customer has filed an application for a provisional moratorium, is being declared bankrupt, goods of the customer are being attached before judgment or under an execution, or his debts are being liquidated.
- 13.3 The damage suffered and yet to be suffered as referred to in article 13.1. shall be at least 10% of the agreed price, without BRAND VAN EGMOND being obliged to prove that this damage has been or will be suffered.
- 13.4 In the event of rescission on the strength of article 13 any credit that BRAND VAN EGMOND has granted the customer shall be claimable immediately without further notice of default being required.

14. Intellectual property rights

- 14.1 The only BRAND VAN EGMOND trademarks and/or other rights of intellectual property that the customer may display to advertise and sell the products, shall be those trademarks and/or intellectual property rights under which the products are sold by BRAND VAN EGMOND to the customer hereunder, or such other trademarks expressly authorized by BRAND VAN EGMOND (hereinafter called "the said trademarks").
- 14.2 The customer shall comply with BRAND VAN EGMOND's instructions as to the manner and context in which the said trademarks and the statements to accompany them are displayed.
- 14.3 No trademarks of the products shall be undertaken by the customer or any person on the customer's behalf without BRAND VAN EGMOND's prior written consent nor will the customer alter, obliterate, add to, or otherwise interfere with the said trademarks and/or other intellectual property rights.

15. Export

- 15.1 The customer is responsible at its own expense for obtaining any licence and complying with any export or import regulations in force within the country for which the products are destined.
- 15.2 BRAND VAN EGMOND reserves the right not to supply certain customers or countries and to seek from the customer full details of the end use and final destination of the products.

16. Force majeure

- 16.1 BRAND VAN EGMOND shall not be liable to the customer in any manner or be deemed to be in breach of these conditions of sale because of any delay in performing or any failure to perform any of BRAND VAN EGMOND's obligations under these conditions of sale if the delay or failure was due to any cause beyond BRAND VAN EGMOND's reasonable control (which shall include, but not be limited to government actions, war, fire, explosion, flood, import or export regulations or embargoes, labour disputes or inability to obtain or a delay in obtaining supplies of products or labour, lack and/or interruptions in the means of transport, production equipment or energy supplies).
- 16.2 BRAND VAN EGMOND may, at its option, delay the performance of, or cancel the whole or any part of a contract.

17. General

- 17.1 Any provision of these conditions of sale which is held by any competent authority to be invalid, void, unenforceable or unreasonable (in whole or in part) shall to the extent of such invalidity, voidness, voidability, unenforceability or unreasonableness be deemed severable and the other provisions of these Conditions of Sale and the remainder of such provision shall not be affected.
- 17.2 Failure by BRAND VAN EGMOND to enforce or partially enforce any provision of these conditions of sale will not be constrained as a waiver of any rights under these conditions of sale.

18. Legal construction

- 18.1 All disputes, suits, actions or other legal proceedings arising out of or related to these conditions of sale shall be governed by and interpreted in accordance with the laws of the Netherlands and the customer submits to the jurisdiction of the courts of the Netherlands, but BRAND VAN EGMOND may enforce such contract in any court of competent jurisdiction.
- 18.2 The United Nations Convention on contracts for the International Sale of Goods (1980) is not applicable (CISG).

All rights reserved, copyright© Brand van Egmond B.V. ® 2023.

For all models, texts, layout and images BrandvanEgmond, Interiors designed by studiodutchdelight.com. Specifications are subject to change without prior notice. Brand van Egmond manufactures exclusive lighting sculptures on a small scale. Because their products are handmade, they can differ from one another. Each product has its own identity and therefore is unique. Each item is labelled with its own number and certificate. Brand van Egmond reserves the right to change their models from time to time without prior notice. The designs, texts, layout or pictures included in this brochure are subject to errors, technical changes and protected by copyright and/or industrial design rights. No part there of may be made public, reproduced or amended in any form or in any manner whatsoever, for commercial purposes by third parties, including dealers, retailers, internet shops and others, without the prior and express written permission of the designer William Brand) .

Colofon

BRAND VAN EGMOND

William Brand

Photography by

Brand Van Egmond

Rendering images and Interior design

Studiosdutchdelight.com



BRAND VAN EGMOND B.V. Nikkelstraat 41, 1411 AH Naarden, The Netherlands
T. +31 (0)35 692 12 59 info@brandvanegmond.com www.brandvanegmond.com

